



General Catalogue of
Ductile Iron Pipes, Fittings and Valves
Accompanied by Installation & Operation Guide

Prepared by :



Hamoun Nyzeh Company

www.hanyco.ir

May 2024

Scope	9
Introduction	10
■ Basic definitions	
Ductile iron History	13
Advantages of ductile iron pipes	17
Applications of ductile iron pipes	17
Ductile iron pipe manufacturing process	18
■ Practical concepts and main specifications of ductile iron pipes and fittings	
Pressure classification according to standard 2009: ISO 2531	21
External diameter (DE)	21
Internal diameter (DN)	22
Wall thickness	22
Wall thickness according to standard ISO 2531: 1998. EN 545: 2007	23
Wall thickness according to standard ISO 2531: 2009 . EN545: 2010	24
Pipe length	25
Straightness	25
Tensile properties	26
Brinell hardness	27
Welding defective pipes	27
Works leak tightness test of pipes and fittings	28
■ Coating and linings for Ductile iron pipes and fittings	
Pure metallic zinc (99.99% Zn)	31
Zinc-Aluminum coating (Zn-15%Al)	32
Bituminous coating	32
Bitumen-Aluminum coating (20% max.)	32
Epoxy	33
Advantages of epoxy coating	33
Cement mortar lining	34
Clogging the cracks and microscopic pores	35
Different cement lining	36
Markings	37
Polyethylene sleeving	37
Polyethylene lining	38
■ Ductile iron pipes with Tyton joint	
Push-on joint (Tyton)	41
Push-on joint advantages	41
Dimension and weights specifications of ductile iron pipes according to ISO 2531: 1998 K9 class	42
Dimension and weights specifications of ductile iron pipes according to EN 545:2007 K9 class	43
Dimension and weights specifications of ductile iron pipes according to ISO 2531:2009 C Class	44
Dimension and weights specifications of ductile iron pipes according to EN 545: 2010 C Class	45
Dimension and weights specifications of ductile iron pipes according to EN 598: 2007 standard	46
Non-preferred Pipes.....	47
■ Ductile iron pipe with anti-seismic flexible restrained joint (R.J.Pipe)	
Ductile iron pipe with anti-seismic flexible restrained joint(R.J.Pipe)	51
Applications	54
Advantages	54

Dimension and weights specifications of ductile iron pipes R.J.Pipe according to ISO 2531: 1998 K9 Class	55
Dimension and weights specifications of ductile iron pipes R.J.Pipe according to ISO 2531: 2009 C Class	56
■ Quake-resistant ductile iron pipe (Q.R.Flex)	
Quake-resistant ductile iron pipe (Q.R.Flex)	59
Dimensions and weighs characteristics of Q.R Flex ductile iron pipes according to ISO 2531: 1998 K9 Class	60
Dimensions and weighs characteristics of Q.R Flex ductile cast iron pipes according to ISO 2531: 2009 C Class	60
Application	63
Advantages	63
■ Ductile iron pipes compatible with plastic (PVC or PE) piping systems	
Light pipe (L.Pipe)	67
Applications	69
Standards	69
Equivalent diameter of L.Pipe pipes and fittings in polymer pipes	70
Dimension and weights specification of L.Pipe	70
Advantages	71
Performance of the L.Pipe	72
List of compatible L.Pipe fittings with polyethylene pipes	73
L.Pipe weight loss rate compared to Tyton pipe	73
■ Ductile iron pipe gasket	
Rubber gasket	77
Dimensions and weights of EPDM rubber gaskets	77
Self-Anchoring Gasket	79
Applications	79
Advantages	79
Rubber gasket for L.Pipe	80
■ Manhole	
Introduction	83
Application of manhole	84
Manhole Standards	85
Technical specification of ductile iron manhole tops	85
Advantages of ductile iron manhole	86
Product safety	86
Shock and noise damper gasket	86
■ Wafer Type Butterfly Valves	
Wafer Type Butterfly Valves	89
Application	89
Special Features	90
Coating specification	90
Material	91
Lever control wafer-type butterfly valve dimensions & weights	92
■ Guide for unloading, storing and loading ductile iron pipes	
Guide for unloading, storing and loading ductile iron pipes	95
Loading	97
Unloading	98
Storage	98
Pipe Arrangement	99

■ Manual of installation and operation

Installation guide	105
Preparation of the piping route	105
Trench Excavation	106
Trench width	106
Trench depth	107
Backfilling around ductile cast iron pipes	107
Installation C-Class pipes	113
Transportation of Pipe and components to the installation site and commission (Threading)	118
Examination before installation	118
Installation Guide for Tyton ductile iron pipes	121
Instructions on installation of RJ Pipe (anti-seismic restrained pipe Fitting)	122
Proper equipment for assembling the ductile cast iron pipes	123
Lubricant	124
Cutting Pipes	124
Proper equipment for cutting pipes	124
Cutting section (Spigot bevel)	124
Ovality	125
Essential equipment for prevention of ovality (400-900 mm)	125
Ovality prevention steps	125
Guide to welding the RJ. Pipe welding (anti-seismic restrained pipe)	126
Post-welding operations	127
Pipeline Hydro test under pressure	127
Pipeline Support	128
Backfilling before test	128
Pipeline filling	128
Preliminary operations	129
Various types of tests	129
Pressure decrease test	129
Constant pressure test	129
Test acceptance criteria	130
Pipe Disinfection	130
Step by Step guide to polyethylene sheath installation	131
Sheath installation on dry trench	131
Sheath installation in a wet trench	133

■ Ductile iron fittings

Ductile iron fittings	137
Dimension specifications of flanged fittings and tyton fittings	139
Dimension specifications of socket weld flanges.....	177
Dimension specifications of flanged gasket	181
Dimension specifications of hexagon head screwst and nuts for flanges	182
Dimension specifications of anti-seismic restrained (RJ) fittings	183
Dimension specifications of L. Pipe fittings	198
Other technical remarks	209
References.....	210



HANYCO

No.28, 3rd. st., Shaghayegh Blvd, Kashani Ave. Tehran, Iran

Postal code: 1483877631

Tel: +98 21 4400 98 11-3 | Fax: +98 21 4400 96 10

USSD: *6655*330#

Introduction





HANYCO



HANYCO warehouse at Kashan

| Scope

This catalog introduces Hamoun Nyzeh Company's product range, including Ductile Iron pipes, fittings, valves, transmission pipes, and manholes made from cast iron for sewerage networks. It covers technical specifications, production methods, and adherence to industry standards, along with guidelines for loading, storage, and warehousing. Our water distribution and transfer section highlights versatile products suitable for conveying water and sewage. These items can be installed above ground or buried underground, offering flexibility for different project needs, whether with or without pressure. Explore our high-quality solutions for efficient infrastructure applications.

Ductile iron pipes and fittings and its characteristics

Introduction

Hamoun Nyzeh Company specializes in producing and supplying high-quality ductile iron pipes and fittings for water and sewage transmission, ranging from 80 to 1200 mm in diameter with a nominal capacity of 120,000 tone per year.

Our facilities, situated on a 24-hectare plot in Kashan city, are equipped to meet infrastructure needs. We have established a robust quality control system and prioritize customer satisfaction, resulting in the attainment of ISO 9001, BS OHSAS 18001, ISO 10004, and ISO 10002 standards. Committed to global benchmarks such as ISO 2531, EN 545, ISO 16631, EN 598, ISO 8179-1, ISO 4179, and ISO 16134, we proudly hold the Standard mark usage certificate from Iran National Standard Organization (INSO) under INSO 21736 and INSO 3732. Additionally, our commitment to quality is recognized by the German DVGW¹ institution, where we obtained a quality establishment certificate.

Our products are designed to transfer drinking water, meeting the standards of the food and drug administration of Iran and the medical science university.

We adhere to the global standard of BS 6920. Certification from Germany's DVGW institution further validates the sanitation compliance of our internal and external coverage, as well as other accessories used in our pipes and ductile iron fittings. Your trust in Hamoun Nyzeh Company ensures reliable and safe water and sewage transmission.

1. Germany's water and gas association is one of the most accredited companies in issuing certificates in the field of water, gas and sewage standards as well as the acknowledgement regarding products' sanitation state.

Basic definitions





HANYCO



Production site and ware house of HANYCO

Ductile Iron History

Ductile iron¹ was discovered as a result of studies conducted in 1948. By adding some magnesium to the cast iron after desulfurization, Sheet graphite can be converted to spherical graphites². This type of cast iron is called ductile iron in the industry. This new discovery spread rapidly around the world and was used to produce a variety of pipes, industrial and engineering components.

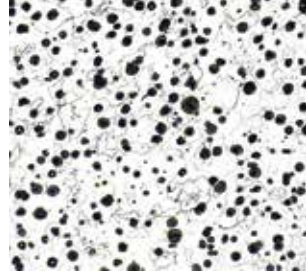

We can indicate the most significant properties of ductile iron as: good casting and machining capability, good abrasion resistance, optimal ductility, high corrosion resistance and also acceptable mechanical properties (Tensile strength, flexibility and surface stiffness).

Pipe: casting of uniform bore, with straight axis, having either socket, spigot or flange ends. Flanged spigots, flanged sockets and collars are excluded in this definition.

Fittings: casting sother than a pipe, which allow pipeline deviation, change of direction or bore. Flanged spigots, flanged sockets and collars are also classified as fittings.

1. Ductile Cast iron (Ductile iron)
2. Spheroidal graphite cast iron (nodular cast iron)

Accessory: any casting other than a pipe or fitting, which is used in a pipeline. Some accessories are listed below:

:: Glands and bolts for mechanical flexible joints.

:: Gland, bolts and locking rings or segments for restrained joints.

Flange: end of a pipe or fitting, extending perpendicularly to its axis, with bolt holes equally spaced in a circle. A flange can be fixed (e.g. integrally cast, screwed-on or welded-on) or adjustable. An adjustable flange comprises a ring, in one or several parts bolted together, which bears on an end joint hub and which can be freely rotated around the barrel axis before jointing.

1- Collar¹: connecting component used to join spigots of two pipes or fittings.

2- Spigot²: male end of a pipe or a fitting.

3- Socket³: female end of a pipe or fitting to make the connection with the spigot of the next component.

4- Gasket⁴: sealing component of a joint.

5- Joint⁵: connection between the ends of pipes and/or fittings in which a gasket is used to effect a seal.

6- Flexible joint⁶: joint providing significant angular deflection and movement parallel and/or perpendicular to the pipe axis.

7- Push-in flexible joint⁷: flexible joint assembled by pushing the spigot through the gasket into the socket of the mating component.

1. Collar

2. Spigot

3. Socket

4. Sealing Gasket

5. Joint

6. Flexible Joint

7. Push-in Flexible Joint

8- Mechanical flexible joint¹: flexible joint in which sealing is obtained by applying pressure to the gasket by mechanical components such as metal ring or gland.

9- Restrained joint²: joint in which a means is provided to prevent separation of the assembled joint.

10- Self-anchoring joint³: It is a type of restrained joint that makes the fitting stronger and more restrained through friction between metallic teeth and pipe's body.

11- Gland⁴: the component that locks the pieces inside a restrained joint, thus leading a joint to be more restrained.

12- Flanged joint⁵: joint between two flanged ends.

13- Nominal size⁶(DN): alphanumeric designation of size for components of a pipework system, which is used for reference purposes. It comprises the letters DN followed by a dimensionless whole number, which is indirectly related to the physical size, in millimeters, of the bore or outside diameter of the end connections.

14- Nominal pressure⁷(PN): numerical designation, which is a convenient rounded number, used for reference purposes. All components of the same nominal size, DN, designated by the same PN number have compatible mating dimensions.

15- Allowable operating pressure⁸(PFA): maximum internal pressure, excluding surge, which a component can safely withstand in permanent service.

16- Maximum allowable operating pressure⁹(PMA): maximum internal pressure, including surge, which a component can safely withstand in service.

1. Mechanical Flexible Joint
2. Restrained Joint
3. Self-anchoring
4. Gland
5. Flanged Join

6. Nominal Size
7. Nominal Pressure
8. Allowable Operating pressure
9. Maximum Allowable operating pressure

17- Allowable site test pressure¹(PEA): maximum hydrostatic pressure that a newly installed component can withstand for a relatively short duration, when either fixed above ground level or laid and backfilled underground, in order to measure the integrity and tightness of the pipeline. This test pressure is different from the system test pressure, which is related to the design pressure of the pipeline.

18- Diametral stiffness² of a pipe: characteristic of a pipe allowing it to resist diametral deflection under loading.

19-Length³: effective length of a pipe and fitting (without the consideration of socket area).

20- Hoop Stress⁴: stress in a pipe or fitting under pressure, acting tangentially to the perimeter of a transverse section.

21- Ovality⁵: out-of-roundness of a pipe section, equal to the equation below:

$$\text{OVALITY} = \left[\frac{A_1 - A_2}{A_1 + A_2} \right] \times 100$$

A₁: Biggest external diameter of pipe (mm)

A₂: Smallest external diameter of pipe (mm)

1. Allowable Site test pressure
2. Diametral Stiffness
3. Effective length
4. Hoop Stress
5. Ovality

Advantages of ductile iron pipes

- :: Instinct resistance of cast iron against corrosion along with improvement of this resistance via various coatings.
- :: Appropriate resistance against internal pressures such as surge and external pressures like traffic loads, etc.
- :: Suitable for use in loose ground with high level of subterranean waters.
- :: Resistance against electrical currents due to use of rubber gasket at the joint points.
- :: Adequate resistance against damages caused by displacement and transportation.
- :: Flexibility and sufficient resistance against landslides, on faults and anti-seismic regions with using restrained ductile iron pipe.
- :: Capability of being cut and drilled.
- :: Appropriate for mountainous areas due to no need for special bedding and precise consideration of soil compaction and trench depth.
- :: High working pressure compared to other types of pipes .
- :: Easy leakage detection as pipes are made of metal.
- :: No need to particular equipment and skilled workforce for assembling and pipeline installation (Due to application of push-in fittings).

Applications of ductile iron pipes

- :: Drinking water transfer and distribution lines
- :: Industrial and domestic sewage networks
- :: Sea water transmission system
- :: Irrigation and drainage networks
- :: Water treatment plant networks
- :: Firefighting systems
- :: Artificial snow making machine

Ductile iron pipe manufacturing process

Hamoun Nyzeh Company manufactures ductile iron pipes by means of centrifugal casting method. This method is among the most famous of its kind in the world, invented in 1920 by a Brazilian engineer, Dimitri De Lavaud, for production of ductile iron pipes under pressure.

In centrifugal casting, a permanent mold is rotated around its axis at high speed as the molten metal is poured. The molten metal is centrifugally thrown towards the inside mold's wall, where it solidifies after cooling then as cast pipe is extracted from mold. The pipes are heat treated in a continuous annealing furnace to change the metal matrix from pearlite to ferrite in order to reduce hardness and improve its ductility and mechanical properties. This process releases the pipe internal stresses and improves grinding and cutting capability.



***Practical concept and main specifications
of ductile iron pipes and fittings***





HANYCO



As cast DN600 ductile iron pipe (Centrifugal casting machine No.2, production site at Kashan)

Pressure classification according to ISO 2531:2009 standard

Components with flexible joints shall be classified by the allowable operating pressure (PFA) in bar, prefixed by the letter C. Components with flanged joints shall be classified by the PN number of the flange.

Allowed component pressure relationships shall be the following:

- a) Allowed operating pressure (PFA)¹ = C, in bar
- b) Allowed maximum operating pressure (PMA)² = 1.2 × PFA, in bar
- c) Allowed site test pressure (PEA) = (1.2 × PFA)³ + 5, in bar



The allowed pressures within a pipeline system shall be limited to the lowest pressure classification of all components within the system.

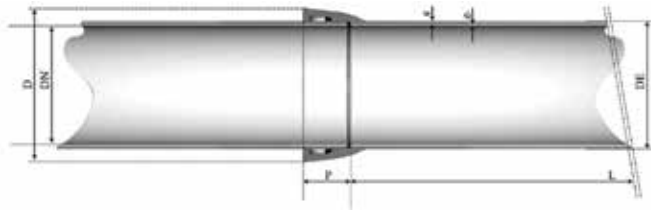

External diameter (DE)

The external diameters (DE) of pipes and fittings spigot end are circumferentially measured. Regarding the possibility that the pipes purchased by a customer turn oval during transportation and maintenance, it is necessary to fulfill the procedure of de-ovalisation prior to assembly.

(For more information refers to Hamoun Nyzeh Company's installation Catalogue).

1. PFA: allowable operating pressure
 2. PMA: maximum allowable operating pressure
 3. PEA: allowable site test pressure

Internal diameter (DN)

The nominal values of internal diameters of centrifugally cast pipes, expressed in millimetres, are approximately equal to “DN” of ductile iron pipe after the application of internal lining.

Ext Dimantion DE or d1 mm	Range	DN
98	Nom	80
95.8	Min	
99	Max	
118	Nom	100
115.2	Min	
119	Max	
144	Nom	125
141.2	Min	
145	Max	
170	Nom	150
167.1	Min	
171	Max	
222	Nom	200
219	Min	
223	Max	
274	Nom	250
270.9	Min	
275	Max	

Ext Dimantion DE or d1 mm	Range	DN
326	Nom	300
322.7	Min	
327	Max	
378	Nom	350
374.6	Min	
379	Max	
429	Nom	400
425.5	Min	
430	Max	
480	Nom	450
476.4	Min	
481	Max	
532	Nom	500
528.2	Min	
533	Max	
635	Nom	600
631	Min	
636	Max	

Ext Dimantion DE or d1 mm	Range	DN
738	Nom	700
733.7	Min	
739	Max	
842	Nom	800
837.5	Min	
843	Max	
945	Nom	900
940.2	Min	
946	Max	
1048	Nom	1000
1043	Min	
1049	Max	
1152	Nom	1100
1146.8	Min	
1153	Max	
1255	Nom	1200
1249.5	Min	
1256	Max	

Wall Thickness

Wall thickness is one of the most effective parameters to specify the pressure that pipes can withstand. The basis for calculating the wall thickness is Barlow equation:

$$t = \frac{PD}{2S}$$

Hamoun Nyzeh Company is capable of producing pipes according to the following standard depending on customer's need and order.

ISO 16631: 2016

EN 545: 2010

ISO 2531: 2009

EN 598: 2007

EN 545: 2007

ISO 2531: 1998

Wall thickness based on ISO 2531:1998. EN 545: 2007 Standards

The nominal iron wall thickness of pipes shall be calculated as a function of the nominal size, DN, by the following formula;

$$e = K(0.5 + 0.001DN)$$

Where "e" is the nominal wall thickness, in millimeters;

"DN" is nominal size

"K" is a coefficient chosen from among such whole numbers as 7, 8, 9, 10, 11, 12, ... used for classification of thickness.

According to this standard, the "K=9" is the most typical thickness class for water supply application.

Product	Thickness (mm)	Tolerance
Centrifugal pipes	6	-1.3
	>6	-(0.001+1.3 DN)
Non-centrifugal pipes and fittings	7	-2.3
	>7	-(2.3+0.001 DN)

Hamoun Nyzeh Company can produce pipes and fittings with un-preferred working pressure according to customer request.

For more information contact Hanyco experts.

Wall thickness based on ISO 2531: 2009 . EN545: 2010

According to these standards, the manufactured pipes are of type C and the number adjacent to it (prefixed by the letter C) indicates the pipe's operating pressure. The minimum wall thickness for pipes, e_{min} , shall be determined using the following equation:

$$e_{min} = \frac{PFA \times SF \times DE}{20R_m + (PFA \times SF)}$$

where e_{min} : is the minimum pipe wall thickness, in millimeters;

PFA: is the allowed operating pressure, in bar;

SF: is the safety factor (=3);

DE: is the nominal pipe external diameter, in millimetres;

R_m : is the minimum tensile strength of ductile iron, in mega pascals ($R_m = 420$ MPa);

The nominal thickness is as follow:

Product	Thickness
Pipes	$e_{nom} = e_{min} + (1.3 + 0.001 \text{ DN})$
Fittings	$e_{nom} = e_{min} + (2.3 + 0.001 \text{ DN})$

Note: The minimum thickness of pipe and fittings should not be less than 3 mm.

Pipe Length

Various types of ductile iron pipes are produced and offered according to the table below and the standard length of 6 meters. When a total length is ordered, HANYCO is able to supply the number of pipes according to the total required length.

Based on the relevant standard, no more than 10% of pipes in each size could be shorter than the standard length. However, pipes cut for testing in factories are exceptions from this rule and are considered standard.

In the following table, the tolerance of pipe's length is presented:

Dimensions in millimeters

Type of casting	Tolerance	
	ISO 2531 :2009	ISO 2531 :1998
Socket and spigot pipes (full length or shortened)	+70 -30	±30
Fittings for socket joints	±20	±20
Pipe and fittings for flanged joints	±10*	±10*

*By agreement between manufacturer and purchaser, smaller tolerances are possible, but not less than ± 3 mm for DN ≤ 600 and ± 4 mm for DN > 600.

Straightness of pipes

Pipes shall be straight, with a maximum deviation of 0.125% of their length.

Tensile properties

Laboratory under the ISO . IEC 17025 license with the most advanced laboratory equipment. Pipes, fittings and accessories made of ductile iron have the tensile properties given in following table.

Pipes and fittings manufactured by Hamoun Nyzeh are mechanically tested for tensile strength, hardness, etc. in compliance with ISO 2531 international standard.

Type of casting	Minimum percentage elongation after fracture		Minimum tensile strength R _m (MPa)
	DN 1100-1200	DN 80-1000	
Pipes centrifugally cast	7	10	420
Fitting and accessories	5		

Brinell hardness

The hardness of ductile iron pipe shall be such that they can be cut, tapped, drilled and/or machined with standard tools.

The Brinell hardness shall not exceed 230 HBW for centrifugally cast pipes and 250 HBW for fittings and accessories.

For components manufactured by welding, a higher Brinell hardness is allowed in the heat-affected zone (HAZ) of the weld.

Welding defective pipes

According to ISO 2531 standard, when necessary, pipes and fittings may be repaired, by welding or other methods, to remove surface imperfections and localized defects which do not affect the entire wall thickness.

Works leaktightness test of pipes and fittings

Pipes and fittings are tested in accordance with international standard ISO 2531 and EN 545. The hydrostatic test is carried out on all pipes and fittings before performing external and internal coatings, except for the metallic zinc coating of pipes which may be performed before the test.

Pipes and fittings are subjected to a hydrostatic test for a duration of at least 15 seconds at the minimum internal test pressures given in following table.

The required test pressure for pipe and fittings based on ISO 2531 international

Pressure in bar:

DN	pipe		Fittings
	Class	ISO 2531 :1998	all working classes
80-300	K=9	50	25
350-600		40	16
700-1000		32	10
1100-1200		25	10

Pressure in bar:

DN	pipe		Fittings
	Class C	ISO 2531 :2009	all working classes
80-300	C40	40	25
350-600	C30	30	16
700-1000	C25	25	10

All fittings manufactured by Hamoun Nyzeh Company undergo a hydrostatic test immediately after the casting process. Additionally, customers have the option to witness this test in our factory premises.

***Coating and linings for Ductile
iron pipes and fittings***





HANYCO



Zinc-15 Aluminum thermal spray coating of DN500 pipes

Pure metallic zinc (99.99% Zn)

Zinc coating is one of the most common types of coating used for ductile iron pipes, which is applied along with the final coating. Zinc is an active element in electrochemical table acting as a sacrificial anode in case of occurring damage on coating and prevents from rusting the metal inner layer. Relying on this specification, the external surface of ductile iron pipes are coated using thermal spray method according to ISO 8179-1 standard.

The minimum amount of zinc coating on external surface of pipe is 200 gr.m². This amount should be not less than 180 gr.m² locally. For less corrosive soils and upon the agreement between customer and producer, the amount of zinc coating could decrease to 130 gr.m² (This amount should be not less than 110 gr.m² locally).

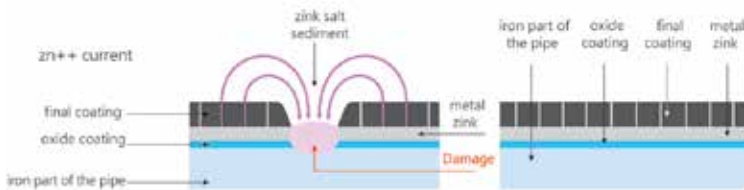

Schematically presentation of Zinc-coated protection mechanism.

Hamoun Nyzeh Company might offer higher amount of zinc coating based on customer's order. This figure schematically indicates the mechanism of metallic zinc coating.

Zinc-Aluminum coting (Zn-15%Al)

Based on research done, Aluminum can render a passive film on iron surface while metal zinc can result in galvanic protection. Thus, a coating of Zinc-Aluminum alloy (Zinc-15% Aluminum) is able to act quite properly as a coating for ductile iron pipes working on various environments. The presence of two metals simultaneously, leads to combine their advantage which eventually forms a resistance and powerful coating against corrosion.

In order to reach protective characteristic according to ISO 8179-1, a Zn-Al coating has to be applied with amount of at least 400 gr.m² on the external pipe's surface.

Bituminous coating

In order to increase resistance against corrosion of soil and other environmental factors, bituminous paint with minimum thickness of 70 microns is sprayed uniformly on the outer surface of pipes (This thickness should be not less than 50 microns locally).

Bitumen-Aluminum coating (20% max.)

In special cases when there is a request for higher corrosion resistance, like using pipes against UV emission, such as in above-ground pipelines, instead of bitumen final coating, there is a possibility to use bitumen coating with a maximum of 20% aluminum.

Epoxy

Epoxy paint is a two-components coating based on special epoxy resin and polyamide hardener. Applying a single layer of epoxy coating, according to international standard ISO 8179, on the surface of pipe which forms a resistant film against corrosive agents. After completion of the epoxy paint reaction, it makes a very hard surface that shows great resistant to scratches, abrasion and chemicals. Epoxy paint coating is applied on the surface of ductile iron pipes.

This coating can protect the inner and outer surfaces against corrosive and abrasive factors in extreme environmental conditions. Because of the diversity of epoxy basic materials, this coating has gained a large variety of qualities and functions. HANYCO is ready to coat various pipes by different epoxy paints according to customer demand.

Some advantages

- :: High resistance against chemicals and corrosives
- :: Proper mechanical and thermal characteristics (high temperature resistance)
- :: High stability and adhesion
- :: Great resistance against abrasion
- :: Electrical insulation

Cement mortar lining

One of the most common lining of ductile iron pipe is cement mortar. Self-healing is considered as one of the unique advantages of this lining. Cement mortar lining is applied by centrifugal method than curing is carried out in an appropriate temperature and humidity condition. From among its advantages, one can mention high density, minimum roughness and adequate adhesiveness. The smooth internal surface can cause higher flow rate and less pressure drop and as a result raise hydraulic efficiency of water.

Characteristic of cement layer in accordance with ISO 4179 are given in this table

Dimensions in millimeters

DN	Lining thickness		Maximum crack width (potable water)	Maximum crack width (sewerage pipeline)
	Minimum (in one point)	Nominal		
80-300	2	3	0.8	0.6
350-600	3	5	0.8	0.7
700-1200	3.5	6	1	0.8

It should be noted that according to the standard thickness of the cement layer at the end of the pipe can be lower than the minimum allowed

It is noteworthy that Hamoun Nyzeh Company is able to apply thicker cement mortar lining according to EN 545 standard. Thus, for more information contact Hanyco experts.

Clogging the cracks and microscopic pores

When cement lined ductile iron pipe is filled with water, a portion of water permeates the pores of lining, thus freeing a considerable amount of calcium hydrate. Calcium hydrate reacts with calcium bicarbonate in the water to precipitate calcium carbonate, which tends to clog the pores of the mortar and increase the strength of cement layer.

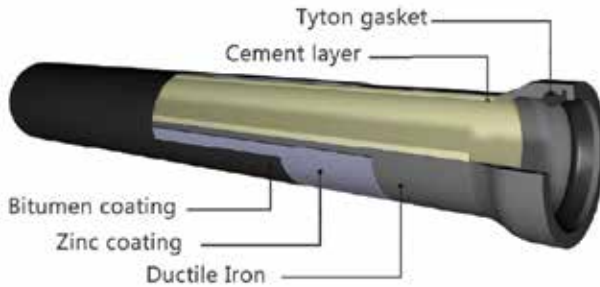

Different cement lining

HANYCO could line its pipes with different kinds of cement layers, according to ISO 2531, EN 545 and EN 598 standards, by customer's request.

:: Portland Cement (anti-sulphate)

:: Blast furnace slag cement

:: High Aluminum cement

:: Characteristic of each type of cement based on EN 545, are given in the following table:

Density in mg.Lit

High Aluminum cement	Anti-sulphate and blast furnace slag cements	Portland cement	Water characteristics
4	5.5	6	Minimum pH
Unlimited	15	7	Corrosive CO ₂
Unlimited	3000	400	SO ₄ ⁻
Unlimited	500	100	Mg ⁺⁺
Unlimited	30	30	NH ₄ ⁺

Markings

All the pipes and fittings are durably and legibly marked according to EN 598, EN 545, ISO 2531 and ISO 16631 and contain following information:

- :: A reference to international standard
- :: The manufacturer's name or mark; i.e. HANYCO
- :: Identification of the year of manufacture;
- :: Identification as ductile iron; (GGG, DI...)
- :: Nominal diameter (DN)
- :: The PN rating of flanges, if applicable;
- :: The C pressure class of socket and spigot pipe, according to ISO 2531:2009, EN 545:2010.

By customer request, HANYCO could provide more information and characteristics. for more information contact Hanyco experts.

Polyethylene sleeving

Polyethylene sleeving are complementary coatings for ductile iron pipes that according to ISO 8180 are used as a cost-effective coating for protecting ductile iron pipelines against corrosive soil.

It should be noted that under normal condition some humidity from soil could penetrate into this sleeving. Although the humidity trapped there could at first be corrosive, but the oxygen content under the sleeving soon comes to end and leading oxidation process to stop.

For more information on maintenance condition, size, installation procedure, etc. see "installation" section in this catalogue.

Hamoun Nyzeh Company can supply Polyethylene sleeving. according to the customer's order.

Polyurethane lining

Hamoun Nyzeh Company has the capability to supply ductile cast iron sewerage pipes that comply with the EN598: 2007 standard, meeting the requirements for polyurethane lining according to the EN15655-1:2018 standard.

The polyurethane internal lining is recognized as a favorable choice for ductile iron sewerage pipes. It not only preserves its corrosion resistance but also retains its anti-scaling properties and flexibility, positively impacting the system's functionality.

Moreover, its drying time is quicker than cement curing time, and it exhibits superior chemical resistance. polyurethane lining demonstrates exceptional resistance to cracking or breaking during transportation or upon impact. Some of the additional benefits of the polyurethane internal lining include:

- :: Suitability for various corrosive acidic and alkaline environments in a wide range of pH.
- :: Creation of a smoother surface compared to cement coatings and a larger internal cross-section.
- :: Minimal pressure drop, no degradation in pump energy efficiency, and enhanced, consequently reducing the operational costs of sewerage transmission piping systems.
- :: Ideal for sewerage pipes with minimal slope.
- :: Effective for highly aggressive liquids and no chemical reaction with chlorine or any other disinfectant.
- :: No breakage or chipping of the lining during pipe drilling or cutting.

The minimum thickness for the polyurethane internal lining conforms to the EN 598: 2007 standard.

DN (mm)	Minimum lining thickness (µm)
80-700	800
800-1200	1000

***Ductile iron pipes with
Tyton joint***





HANYCO



Blue epoxy DN300 C30 pipes

Push-on Joint (Tyton)

One of the most common type of joints used for ductile iron pipes is Push-On joint (Tyton) which can be assembled easily and quickly. This joint includes a rubber gasket with a special material and design that placed inside the socket of pipe so that the next pipe's spigot could fit into by pressure and get assembled and sealed at the same time. These rubber gaskets are made of EPDM according to ISO 4633 & EN 681-1 standard.

Size (DN)	Maximum angular deviation (degree)
80-150	5
200-300	4
350-600	3
700-1200	2

Push-on joint advantages

- :: Easy and fast installation, without special equipment and expert manpower
- :: Proper angular deflection
- :: Not require welding and using bolt and nut
- :: Perfect sealing



Dimension and weights specifications of ductile iron pipes according to ISO 2531:1998 K9 Class

Ductile iron pipe with push-on joint (Tyton)
According to ISO 2531: 1998 K Class

DN	External diameter (DE)		Pipe length (L)	Socket Length (P)	Socket external diameter (D)	Nominal thickness (e)	Nominal Cement thickness (e ₁)	Pipe weight with internal cement and external coatings
	(mm)		(m)	(mm)	(mm)	(mm)	(mm)	(Kg)
80	Nominal	98	6	85	142	6.0	3	87
100	Nominal	118	6	88	164	6.0	3	106
125	Nominal	144	6	91	196	6.0	3	132
150	Nominal	170	6	94	217	6.0	3	157
200	Nominal	222	6	100	278	6.3	3	217
250	Nominal	274	6	105	332	6.8	3	286
300	Nominal	326	6	110	388	7.2	3	362
350	Nominal	378	6	110	442	7.7	5	474
400	Nominal	429	6	110	497	8.1	5	567
450	Nominal	480	6	115	551	8.6	5	669
500	Nominal	532	6	120	606	9.0	5	774
600	Nominal	635	6	120	715	9.9	5	1008
700	Nominal	738	6	150	828	10.8	6	1299
800	Nominal	842	6	160	940	11.7	6	1596
900	Nominal	945	6	175	1044	12.6	6	1934
1000	Nominal	1048	6	185	1156	13.5	6	2258
1100	Nominal	1152	6	166	1264	14.4	6	2613
1200	Nominal	1255	6	171	1314	15.3	6	3002

All dimensions except pipe length are presented in mm (millimeter) and kilogram (kg) for weights. Additionally, dimensions and weights are mentioned without tolerance consideration. All weights are calculated based on thickness class (K9). In the case of other thickness classes, please contact Hanyco technical experts.

Dimension and weights specifications of ductile iron pipes according to EN 545:2007 K9 Class

Ductile iron pipe with push-on joint (Tyton)
According to EN 545: 2007 K Class

DN	External diameter (DE)	Pipe length (L)	Socket Length (P)	Socket external diameter (D)	Nominal thickness (e)	Nominal Cement thickness (e ₁)	Pipe weight with internal cement and external coatings
	(mm)	(m)	(mm)	(mm)	(mm)	(mm)	(Kg)
80	Nominal 98	6	85	142	6.0	4	90
100	Nominal 118	6	88	164	6.0	4	111
125	Nominal 144	6	91	196	6.0	4	137
150	Nominal 170	6	94	217	6.0	4	163
200	Nominal 222	6	100	278	6.3	4	225
250	Nominal 274	6	105	332	6.8	4	296
300	Nominal 326	6	110	388	7.2	4	375
350	Nominal 378	6	110	442	7.7	5	474
400	Nominal 429	6	110	497	8.1	5	567
450	Nominal 480	6	115	551	8.6	5	669
500	Nominal 532	6	120	606	9.0	5	774
600	Nominal 635	6	120	715	9.9	5	1008
700	Nominal 738	6	150	828	10.8	6	1299
800	Nominal 842	6	160	940	11.7	6	1596
900	Nominal 945	6	175	1044	12.6	6	1934
1000	Nominal 1048	6	185	1156	13.5	6	2258
1100	Nominal 1152	6	166	1264	14.4	6	2613
1200	Nominal 1255	6	171	1314	15.3	6	3002

All dimensions except pipe length are presented in mm (millimeter) and kilogram (kg) for weights. Additionally, dimensions and weights are mentioned without tolerance consideration. All weights are calculated based on thickness class (K9). In the case of other thickness classes, please contact Hanyco technical experts.

Dimension and weights specifications of ductile iron pipes according to ISO 2531:2009 C Class (Preferred class)

Ductile iron pipe with push-on joint (Tyton)
According to ISO 2531: 2009 C Class (Preferred Class)

DN	External diameter (DE)	Pipe length (L)	Preferred pressure class	Socket Length (P)	Socket external diameter (D)	Nominal thickness (e)	Nominal Cement thickness (e ₁)	Pipe weight with internal cement and external coatings
	(mm)	(m)	(bar)	(mm)	(mm)	(mm)	(mm)	(Kg)
80	Nominal 98	6	C40	85	142	4.4	3	69
100	Nominal 118	6	C40	88	164	4.4	3	84
125	Nominal 144	6	C40	91	196	4.5	3	106
150	Nominal 170	6	C40	94	217	4.5	3	126
200	Nominal 222	6	C40	100	278	4.7	3	172
250	Nominal 274	6	C40	105	332	5.5	3	243
300	Nominal 326	6	C40	110	388	6.2	3	321
350	Nominal 378	6	C30	110	442	6.3	5	410
400	Nominal 429	6	C30	110	497	6.5	5	479
450	Nominal 480	6	C30	115	551	6.9	5	568
500	Nominal 532	6	C30	120	606	7.5	5	672
600	Nominal 635	6	C30	120	715	8.7	5	910
700	Nominal 738	6	C25	150	828	8.8	6	1110
800	Nominal 842	6	C25	160	940	9.6	6	1362
900	Nominal 945	6	C25	175	1044	10.6	6	1685
1000	Nominal 1048	6	C25	185	1156	11.6	6	2028
1100	Nominal 1152	6	C25	166	1264	12.6	6	2345
1200	Nominal 1255	6	C25	171	1314	13.6	6	2726

All dimensions except pipe length are presented in mm (millimeter) and kilogram (kg) for weights. Additionally, dimensions and weights are mentioned without tolerance consideration. All weights are calculated based on thickness class (K9). In the case of other thickness classes, please contact Hanyco technical experts.

Dimension and weights specifications of ductile iron pipes according to EN 545: 2010 C Class (Preferred class)

Ductile iron pipe with push-on joint (Tyton)
According to EN 545: 2010 C Class (Preferred Class)

DN	External diameter (DE)	Pipe length (L)	Preferred pressure class	Socket Length (P)	Socket external diameter (D)	Nominal thickness (e)	Nominal Cement thickness (e ₁)	Pipe weight with internal cement and external coatings
	(mm)	m	(bar)	(mm)	(mm)	(mm)	(mm)	(Kg)
80	Nominal 98	6	C40	85	142	4.4	4	72
100	Nominal 118	6	C40	88	164	4.4	4	88
125	Nominal 144	6	C40	91	196	4.5	4	111
150	Nominal 170	6	C40	94	217	4.5	4	132
200	Nominal 222	6	C40	100	278	4.7	4	181
250	Nominal 274	6	C40	105	332	5.5	4	253
300	Nominal 326	6	C40	110	388	6.2	4	333
350	Nominal 378	6	C30	110	442	6.3	5	410
400	Nominal 429	6	C30	110	497	6.5	5	479
450	Nominal 480	6	C30	115	551	6.9	5	568
500	Nominal 532	6	C30	120	606	7.5	5	672
600	Nominal 635	6	C30	120	715	8.7	5	910
700	Nominal 738	6	C25	150	828	8.8	6	1110
800	Nominal 842	6	C25	160	940	9.6	6	1362
900	Nominal 945	6	C25	175	1044	10.6	6	1685
1000	Nominal 1048	6	C25	185	1156	11.6	6	2028
1100	Nominal 1152	6	C25	166	1264	12.6	6	2345
1200	Nominal 1255	6	C25	171	1314	13.6	6	2726

All dimensions except pipe length are presented in mm (millimeter) and kilogram (kg) for weights. Additionally, dimensions and weights are mentioned without tolerance consideration. All weights are calculated based on thickness class (K9). In the case of other thickness classes, please contact Hanyco technical experts.

**Dimensions and weights Specification of ductile iron pipes
according to EN 598:2007 standard.**

Ductile iron pipe with push-on joint (Tyton) for sewerage applications
According to EN 598: 2007

DN	External diameter (DE)	Pipe length (L)	Socket Length (P)	Socket external diameter (D)	Nominal thickness (e)	Nominal Cement thickness (e ₁)	Pipe weight with internal cement and external coatings
	(mm)	(m)	(mm)	(mm)	(mm)	(mm)	(Kg)
80	98	6	85	142	4.8	4	77
100	118	6	88	164	4.8	4	94
125	144	6	91	196	4.8	4	116
150	170	6	94	217	4.8	4	138
200	222	6	100	278	4.9	4	186
250	274	6	105	332	5.3	4	246
300	326	6	110	388	5.6	4	309
350	378	6	110	442	6.0	5	395
400	429	6	110	497	6.3	5	468
450	480	6	115	551	6.7	5	555
500	532	6	120	606	7.0	5	638
600	635	6	120	715	7.7	5	829
700	738	6	150	828	9.6	6	1186
800	842	6	160	940	10.4	6	1455
900	945	6	175	1044	11.2	6	1763
1000	1048	6	185	1156	12.0	6	2082
1100	1152	6	200	1264	14.4	6	2613
1200	1255	6	215	1314	15.3	6	3002

The dimensions and weights are in accordance with the EN 598:2007 standard and without tolerance consideration. Therefore, if you need thickness classes of other ductile iron pipe standards, contact Hanyco's technical experts.

Non-preferred Pipes

DN	Peripheral Diameter	Pipe's body nominal Thickness (mm)						
		Class 20	Class 25	Class 30	Class 40	Class 50	Class 64	Class 100
80	98				4.4	4.4	4.4	4.8
100	118				4.4	4.4	4.4	5.5
125	144				4.5	4.5	4.8	6.5
150	170				4.5	4.5	5.3	7.4
200	222				4.7	5.4	6.5	9.2
250	274				5.5	6.4	7.8	11.1
300	326			5.1	6.2	7.4	8.9	12.9
350	378		5.1	6.3	7.1	8.4	10.2	14.8
400	429		5.5	6.5	7.8	9.3	11.3	16.5
450	480		6.1	6.9	8.6	10.3	12.6	18.4
500	532		6.5	7.5	9.3	11.2	13.7	20.2
600	635		7.6	8.7	10.9	13.1	16.1	23.8
700	738	7.3	8.8	9.9	12.4	15	18.5	27.5
800	842	8.1	9.6	11.1	14	16.9	21	
900	945	8.9	10.6	12.3	15.5	18.8	23.4	
1000	1048	9.8	11.6	13.4	17.1	20.7		
1100	1152	10.6	12.6	14.7	18.7	22.7		
1200	1255	11.4	13.6	15.8	20.2			



Preferred pressure class



Non-preferred pressure class

Note: Hamoun Nyzeh Company has the capability of producing non-preferred pipes in C class according to ISO 2531-2009 standard based on customer's request.



Centrifugal casting machine No.3, as cast DN 400 pipe

***Ductile iron pipe with anti-seismic
flexible restrained joint (R.J.Pipe)***





HANYCO



DN 250 R.J. ductile iron pipe with EPDM gasket and Portland cement mortar lining

Ductile iron pipe with anti-seismic flexible restrained joint (R.J.Pipe)

R.J.Pipe is the HANYCO's first generation of restrained joint. It is an advanced design of Push-On flexible restrained joint whose it's locking system prevents from pipe separation while seismic or subsidence. Therefore, these types of pipes are known as anti-seismic flexible restrained joint.

This product is designed in compliance with the ISO16134 standard and has undergone performance tests as per ISO10804. The external and internal coatings of these pipes are applied in accordance with ISO8179 and ISO4633, respectively. The manufacturing process of these restrained joint pipes also meets the standards of ISO2531 and EN545.

It is noteworthy that increased safety in water supply networks and significant decrease in water-loss are among the most important advantages of using such pipes.



Using restrained joint leads to the integration of pipeline and distribution of stress and strain that is produced among different components of pipeline.

One of the main specification of this kind of joint is ease of assembly and disassembly without bolt and nut.

Hamoun Nyzeh Company is equipped with special laboratories for carrying out exclusive tests related to the R.J.Pipe's performance according to EN 545 and ISO 10804 standards. After a new joint design or applying an effective modification on the joint, by using these advanced facilities, HANYCO is able to performs all the operational and performance tests on the joint to verify design specification.



Details of operational tests performed for the purpose of identifying the proper joint performance and also determining the technical parameters of a restrained joint are described as following table:

Items	Method	Conditions	Position	Objects	References
1	Positive internal hydrostatic Pressure	Test Pressure: (1.5 PFA+5 bar) Test Duration: 2hr No visible leakage	With Shear load: (50DN)	To prove the joint's capacity to withstand the hydraulic pressure	EN 545 ISO 2531 ISO 10804
			Deflected		
2	Negative Internal Pressure	Test Pressure: -0.9 bar Test Duration: 2hr Maximum Pressure change during the test: 0.09 bar	With Shear load: (50DN)	To prove that the joint is airtight	EN 545 ISO 2531 ISO 10804
			Deflected		
3	Positive External Hydrostatic Pressure	Test Pressure: 2 bar Test Duration: 2hr No visible leakage	With Shear load (50DN)	To prove that the joint is resistant to ground water	EN 545 ISO 2531 ISO 10804
4	Cyclic Internal Hydrostatic Pressure	24000 Cycles PMA to PMA-5 No Visible Leakage	With Shear load (50DN)	To prove the joint fatigue performance	EN 545 ISO 2531 ISO 10804

0.9 bar below atmospheric pressure (approximately 0.1 bar of absolute pressure)

Additionally, the slip-out resistance of R.J.Pipe's joint is measured based on ISO 16134 Standard using special devices.

This joint is selected as one of the best "anti-seismic flexible restrained joint by the "American's association of ductile iron pipes" in an scientific article titled:
 "R.W. Bonds, Ductile iron pipe fittings and their uses"
 March2017.



Applications

- :: Suitable for anti-seismic regions and unstable soils, without concrete thrust blocks in the joint place.
- :: Suitable for trenchless application systems.
- :: Suitable for bridge crossing, horizontal directional drilling, highway and railroad crossing.

Advantages

- :: Suitable Axial displacement and angular deflection with perfect sealing.
- :: Easy and fast installation without nut and bolt.
- :: High resistance against hydraulic forces.

Dimension and weights specifications of ductile iron pipes

R.J.Pipe according to ISO 2531: 1998 K9 Class

Ductile iron pipe with push-on joint (R.J.Pipe)
According to ISO 2531: 1998 K Class (Preferred Class)

DN	External diameter DE	Pipe length L	Socket length P	Nominal thickness e	Pipe weight with internal cement lining and external coatings	Gland external diameter D	Gland weight	Gland width t	Pipe weight with internal cement lining and external coatings and Gland
	(mm)	(m)	(mm)	(mm)	(Kg)	(mm)	(Kg)	(mm)	(Kg)
80	98	6	84	6	87	207	7	83	94
100	118	6	88	6	107	229	8	86	115
125	144	6	91	6	132	256	9	87	142
150	170	6	94	6	158	287	11	94	169
200	222	6	100	6.3	217	347	15	94	233
250	274	6	105	6.8	287	405	20	97	307
300	326	6	110	7.2	363	463	27	101	390
350	378	6	110	7.7	476	518	35	101	511
400	429	6	110	8.1	568	574	36	104	605
450	480	6	120	8.6	670	632	45	104	716
500	532	6	120	9	775	690	55	108	831
600	635	6	120	9.9	1010	810	73	109	1083
700	738	6	150	10.8	1302	932	111	128	1413
800	842	6	160	11.7	1600	1050	147	140	1747
900	945	6	175	12.6	1942	1172	185	164	2127

All dimensions except pipe length are presented in mm (millimeter) and kilogram (kg) for weights. Additionally, dimensions and weights are mentioned without tolerance consideration. All weights are calculated based on thickness class (K9). In the case of other thickness classes, please contact Hanyco technical experts.

Dimension and weights specifications of ductile iron pipes R.J.Pipe according to ISO 2531: 2009 C Class

Ductile iron pipe with push-on joint (R.J.Pipe)
According to ISO 2531: 2009 C Class (Preferred Class)

DN	External diameter DE	Preferred pressure class	Pipe length L	Socket length P	Nominal thickness e	Pipe weight with internal cement lining and external coatings	Gland external diameter D	Gland weight	Gland width t	Pipe weight with internal cement lining and external coatings and Gland
	(mm)	(bar)	(m)	(mm)	(mm)	(Kg)	(mm)	(Kg)	(mm)	(Kg)
80	98	40	6	84	4.4	72	207	7	83	79
100	118	40	6	88	4.4	88	229	8	86	96
125	144	40	6	91	4.5	110	256	9	87	119
150	170	40	6	94	4.5	131	287	11	94	142
200	222	40	6	100	4.7	180	347	15	94	195
250	274	40	6	105	5.5	251	405	20	97	271
300	326	40	6	110	6.2	328	463	27	101	355
350	378	30	6	110	6.3	421	518	35	101	456
400	429	30	6	110	6.5	495	574	36	104	531
450	480	30	6	120	6.9	586	632	45	104	631
500	532	30	6	120	7.5	690	690	55	108	745
600	635	30	6	120	8.7	928	810	73	109	1001
700	738	25	6	150	8.8	1145	932	111	128	1256
800	842	25	6	160	9.6	1404	1050	147	140	1551
900	945	25	6	175	10.1	1642	1172	185	164	1827

All dimensions except pipe length are presented in mm (millimeter) and kilogram (kg) for weights. Additionally, dimensions and weights are mentioned without tolerance consideration. All weights are calculated based on thickness class (K9). In the case of other thickness classes, please contact Hanyco technical experts.

**Quake-resistant ductile iron pipe
(Q.R.Flex)**





HANYCO



DN150 Q.R. flex ductile iron pipe

Quake-resistant ductile iron pipe (Q.R.Flex)



Q.R.Flex is the Hanyco's newest product. It is a push-on flexible restrained joints with same assembly force similar to tyton joint. One of the unique specifications of Q.R.Flex pipe is its suitable angular deflection and axial movement.

QR-Flex Pipes provide flexible restrained push-on joints for 150 to 250mm Ductile Iron pipe. The QR-Flex Restrained Joint has a working pressure rating equivalent to the working pressure rating of the parent pipe, with a maximum restrained joint working pressure rating of 40bar. Q.R.Flex pipe utilize the conventional Tyton gasket for sealing, that it makes installation much easier and faster.

A ductile iron locking ring, inserted through a slot in the bell face, provide a positive axial lock between the bell interior surface and a retainer weldment on the spigot end of the pipe.

Q.R.Flex resistant joint provides a chain structure along the pipeline so it can distributes the created forces in different points along the pipeline.

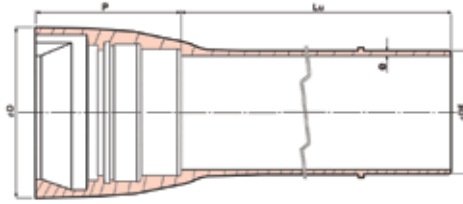

Dimensions and weighs characteristics of Q-R Flex ductile iron pipes according to ISO 2531:1998 K9 Class

DN	External diameter (DE)	Pipe length (Lu)	Socket Length (P)	Socket external diameter (D)	Nominal thickness (e)	Pipe weight with internal cement and external coatings
	(mm)	(m)	(mm)	(mm)	(mm)	(Kg)
150	Nominal 170	6	155	227	6.0	160
200	Nominal 222	6	163	295	6.3	224
250	Nominal 274	6	165	350	6.8	293

All dimensions except pipe length are presented in mm (millimeter) and kilogram (kg) for weights. Additionally, dimensions and weighs are mentioned without tolerance consideration. All weighs are calculated based on thickness class (K9). In the case of other thickness classes, please contact Hanyco technical experts.

Cement thickness in various sizes is similar to Tyton joint.

Dimensions and weighs characteristics of Q-R Flex ductile cast iron pipes according to ISO 2531:2009 C Class

DN	External diameter (DE)	Pipe length (Lu)	Preferred Pressure Class	Socket Length (P)	Socket external diameter (D)	Nominal thickness (e)	Pipe weight with internal cement and external coatings
	(mm)	(m)	(bar)	(mm)	(mm)	(mm)	(Kg)
150	170	6	C40	155	227	4.5	134
200	222	6	C40	163	295	4.7	190
250	274	6	C40	165	350	5.5	264

All dimensions except pipe length are presented in mm (millimeter) and kilogram (kg) for weights. Additionally, dimensions and weighs are mentioned without tolerance consideration. All weighs are calculated based on the preferred pressure class. In the case of non-preferred pressure classes, please contact Hanyco technical experts.

Cement thickness in various sizes is similar to Tyton joint.

Water distribution and transmission pipelines during their useful lifetime are subjected to numerous types of pressure.

This naturally includes standard service pressure, but also the following

- :: Day.Night pipe pressure cycles;
- :: Water hammer (surge);
- :: Pressure drops;
- :: External pressure from the earth, ground water;
- :: Period without pressure prior to commencement of operations;

In each of these situations, the joints are subjected to specific types of stress by named Thrust Forces. For this reason, all joints for ductile iron pipelines are designed and tested in accordance with strict methods in a unique accredited laboratory.

For this purpose, all pipes and fittings manufactured by Hanyco, in Accredited Laboratory are subjected to functional tests under the most difficult conditions possible.

Q.R Flex joint are operationally tested according to ISO 10804 and EN 545 standards similar to R.j.Pipe.

The description of performance tests used to identify the proper function of Q. R. Flex as well as technical parameters of a joint are as follow:

Items	Method	Conditions	Position	Objects	References
1	Positive internal hydrostatic Pressure	Test Pressure: (1.5 PFA+5 bar) Test Duration: 2hr No visible leakage	With Shear load: (50DN)	To prove the joint's capacity to withstand the hydraulic pressure	EN 545 ISO 2531 ISO 10804
			Deflected		
2	Negative Internal Pressure	Test Pressure: -0.9 bar Test Duration: 2hr Maximum Pressure change during the test: 0.09 bar	With Shear load: (50DN)	To prove that the joint is airtight	EN 545 ISO 2531 ISO 10804
			Deflected		
3	Positive External Hydrostatic Pressure	Test Pressure: 2 bar Test Duration: 2hr No visible leakage	With Shear load (50DN)	To prove that the joint is resistant to ground water	EN 545 ISO 2531 ISO 10804
4	Cyclic Internal Hydrostatic Pressure	24000 Cycles PMA to PMA-5 No Visible Leakage	With Shear load (50DN)	To prove the joint fatigue performance	EN 545 ISO 2531 ISO 10804

0.9 bar below atmospheric pressure (approximately 0.1 bar of absolute pressure)

In addition, HANYCO studies all its new joints using scientific finite element methods similar to those used in aeronautical and car industries. These design methods and tests guarantee unbeatable durability and reliability.

Application

- :: Suitable for all types of soils and grounds especially regions having unstable soil or marshes
- :: Regions where installation of inhibitory concrete block is impossible
- :: Suitable for trenchless application systems especially horizontal directional drilling
- :: In high-steep and hilly regions
- :: On faults and seismic-prone regions

Advantages

- :: Improving pipeline resistance against thrust forces and joint protrusion and creating a chain structure in pipeline
- :: Reduction execution costs due to needing no shock-absorbing and cement thrust blocks.
- :: Easy and quick assembly operation without any glands, bolts and nuts
- :: Increase the water networks safety against dangers due to seismic and land sliding.
- :: Considerable reduction of loss-water in transferring pipeline and distribution networks

Schematic of horizontal directional drilling (HDD)





DN150 Q.R flex pipe joint with steel ring and correspondent nut and bolt

**Ductile iron Light Pipe
(L.Pipe)**





HANYCO



Light Pipe (L.Pipe)

Introduction:

In recent years Polyethylene, PVC and GRP pipes have been used abundantly in drinking water supply systems.

The competitors of such pipes in the field of drinking water distribution are metal pipes. Higher cost and weight of metal pipes make their transportation difficult and their low availability in comparison with polymer pipes in the market has led to their smaller share in drinking water distribution.

L.Pipes are a new generation of ductile iron pipes whose nominal diameter is based on external diameter (DN.OD) and match with polymeric pipes completely. In addition, they are manufactured according to polymeric pipes standards. These pipes can be easily joined with PE and PVC pipes or even replaced with them in water distribution lines.

On the other hand, the wall thickness of L.pipe is less than ductile iron pipes, and therefore the weight of these pipes has been significantly reduced (at least 40%) and the usage of this pipe in the drinking water distribution network is very reasonable and economical.

The special design of these pipes in the connection area allows a suitable angular deviation to be available to the designer and operator of the pipeline. On the other hand, the manpower required for transporting and assembling the pipes has been significantly reduced compared to ordinary ductile iron pipes.

Due to the unique properties of Ductile iron such as inherent corrosion resistance and Recognized benefits of ductile iron pipes, including good impact resistance and pressure on pipelines, lower pumping cost due to lower flow drop, Reducing the likelihood of illegal Branching, ease of branching, less breakage and leakage and longer life than polymer pipes, along with the capabilities of Light (L)pipes, these pipes can be considered as a suitable alternative to polymer pipes.

Lower weight and easy transportation, reasonable cost and acceptable performance have made this type of pipe really acceptable among customers. Hanyco is proud to offer various types of fittings which are proper for all types of polymeric and L.pipes made of ductile cast iron. These fittings include: Spigot flange, silent flange, trap, tee, etc.

Applications

- :: In regions with limited access to which it is rarely possible to carry pipes with usual weight
- :: A suitable replacement for polymeric pipes in drinking water distribution network
- :: The best choice in distribution lines with low working pressure
- :: Applicable for repair and maintenance of polymeric pipe distribution networks
- :: Capable of with standing higher external forces in comparison with polymeric pipes.

Standards

L.Pipe is designed, manufactured and tested according to ISO 16631 international standard and INSO 21376 national standard. Moreover, fittings applicable to L.pipe and polymeric pipes are designed and manufactured according to BS EN 12842 standard.

The inner lining of L.Pipe is anti-sulphate portland cement and is applied by centrifugal method according to ISO 4179 standard.

The outer coatings include zinc (with the minimum amount: 200 g.m²) and green epoxy. polyurethane as finishing layer with minimum thickness of 70 microns according to ISO 8179 standard .

For other coatings specification,
contact Hanyco technical experts.

Equivalent diameter of L.Pipe in comparison with polymeric pipes:

Conformity of DN.OD size of L.Pipe and polymer pipes are given in the table below:

PE and PVC pipe size	LP Pipe
DN.OD 90	DN.OD 90
DN.OD 110	DN.OD 110
DN.OD 125	DN.OD 125
DN.OD 160	DN.OD 160
DN.OD 200	DN.OD 200

Dimension and weights specification of L.Pipe

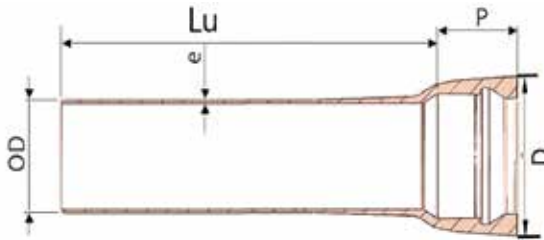

Dimension and weights specification of L.Pipe according to ISO 16631

DN	External diameter DE	Pipe length L	Preferred Pressure	Socket Length P	Socket external diameter D	Maximum angular deflection	Nominal thickness e	Nominal Cement thickness e ₁	Pipe weight with internal cement lining and external coatings
	(mm)	(m)	(Bar)	(mm)	(mm)	Degree	(mm)	(mm)	(Kg)
90	nominal 90	6	C25	84	127	6	3	3	47
110	nominal 110	6	C25	87	148	6	3	3	58
125	nominal 125	6	C25	92	164	6	3	3	67
160	nominal 160	6	C25	97.5	202	6	3.2	3	90
200	nominal 200	6	C25	108	247	6	3.4	3	121

All dimensions except pipe length are in mm and weights are in Kg. Dimensions and weights are mentioned without tolerance consideration.

Advantages

- :: Green products with high scrap value
 - :: Completely competitive price compared to polymer pipes
 - :: Having a variety of fittings for installation and compliance with polymer pipes
 - :: Easy leak detection due to the conductivity of the pipe body
 - :: Having a suitable angular deviation of up to 6 degrees
 - :: Being lighter than ordinary metal pipes
 - :: Ease of branching
 - :: Design perfectly compatible with all types of polymer pipes
 - :: Eco-friendly and compliant with environmental requirements
 - :: Less failures in the distribution network
 - :: Less maintenance
 - :: Eliminate leaks and reduce water loss in the network compared to use of polymer pipes
 - :: Reducing the common efficiency drop in the polymer pipe distribution network
 - :: Pipe assembly using only crowbar one and by hand due to the low weight of L.Pipe pipes
 - :: Much easier to install, use and cut at the installation site, less trench width required and
- Very easy to carry on site
- :: Save on transportation costs and relocation of pipes from the factory to the installation site
 - :: Storage, transportation and depot much easier than polymer pipes
 - :: Impossibility of unauthorized branching
 - :: Eliminate restrictions on outdoor storage and storage of polymer pipes
 - :: No transfer of harmful chemicals to drinking water
 - :: Provide more hydraulic diameter than polymer pipes

Performance of the L.Pipe

L.Pipes joint is designed and tested in accordance with strict methods in a unique accredited laboratory. The table below gives the details of operational tests that were run on the L.Pipe joint.

Items	Method	Conditions	Position	Objects	References
1	Positive internal hydrostatic Pressure	Test Pressure: (1.5 PFA+5 bar) Test Duration: 2hr No visible leakage	With Shear load: (50DN)	To prove the joint's capacity to withstand the hydraulic pressure	EN 545 ISO 2531 ISO 10804
			Deflected		
2	Negative Internal Pressure	Test Pressure: -0.9 bar Test Duration: 2hr Maximum Pressure change during the test: 0.09 bar	With Shear load: (50DN)	To prove that the joint is airtight	EN 545 ISO 2531 ISO 10804
			Deflected		
3	Positive External Hydrostatic Pressure	Test Pressure: 2 bar Test Duration: 2hr No visible leakage	With Shear load (50DN)	To prove that the joint is resistant to ground water	EN 545 ISO 2531 ISO 10804



L.Pipe fittings

For the purpose of completing a pipeline, various types of L.pipes fittings are manufactured by Hamoun Nyzeh Company.

The sockets are designed in a manner which makes the join to polymeric pipes and L. Pipes easy.

The angular deviation of L.Pipe fittings is about 6 degrees, making the design and installation of pipeline very easy.

List of compatible L.Pipe fittings with polyethylene pipes.

Row	Fitting
1	Collar
2	All types of Bends (11.25° , 22.5° . 45° . 90° and Duckfoot)
3	All types of Tees (All socket tee, Double socket with flange tee, etc.)
4	Taper
5	Flanged Spigot
6	Flanged Spigot

L.Pipe weight loss rate compared to Tyton pipe

The weight loss of L.Pipe compared to ordinary Ductile iron cast iron pipe with a suitable size is between 40 to 50%.



DN100 L-pipe with green epoxy paint

Ductile iron pipe gasket





HANYCO



TYTON sit plus EPDM gasket: Featuring a special hardened metal inlay with extra teeth for a secure socket connection

Rubber gasket

Rubber gasket for sealing ductile iron pipes, which is provided by Hamoun Naizeh Company, is made of EPDM with highest quality in accordance with the ISO4633 and EN681-1 standards.

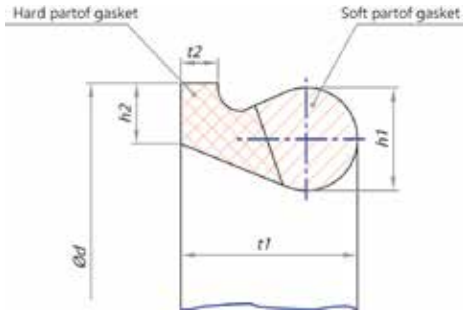

Rubber gasket for push-on joint
(Tyton Pipes, R.J Pipes and Q.R. Flex Pipes)

DN	d	h1	h2	t1	t2	Weight
80	126	16	10	26	5	0.13
100	146	16	10	26	5	0.15
125	173	16	10	26	5	0.18
150	200	16	10	26	5	0.22
200	256	18	11	30	6	0.36
250	310	18	11	32	6	0.47
300	366	20	12	34	7	0.66
350	420	20	12	34	7	0.76
400	475	22	13	38	8	1.05
450	528	22	13	40	8	1.2
500	583	25	14	42.5	9	1.6
600	692	27	15	46.5	10	2.3
700	809	33.5	20	56.2	16	4.2
800	919	35.5	21	60.7	16	5.4
900	1026	37.5	22	66.25	18	7.4
1000	1133	39.5	23	70.75	18	8.7

All dimensions are presented in mm (millimeter) and kilogram (kg) for weights. Additionally, dimensions and weights are mentioned without tolerance consideration.

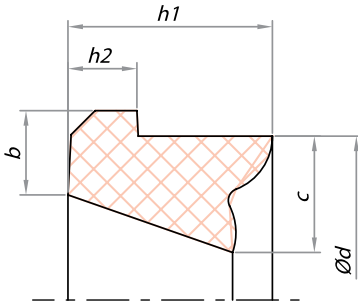

Rubber gasket for push-on joint
(Tyton Pipes, R.J Pipes and Q.R. Flex
Pipes)

DN	d	b	c	h1	h2	Weight
1100	1217.7	26.3	35.9	63	21	7.3
1200	1326.2	28.1	38.8	68.2	23	9.5

Characteristics and technical specifications of this sealing rubber gasket are given in the table below:

Technical specifications	
Hardness-hard area of DN80-DN1000 (shore-A)	85±5
Hardness-sealing area of DN80-DN1000 (shore-A)	55±5
Hardness of DN1100-DN1200 washers (shore-A)	67±3
Density (gr.cm ³)	0.86
tensile strength (MPa)	min 9
Maximum operating temperature (C)	85

According to ISO 4633 and ISO 2230 standards, gaskets should be kept in the following conditions:

- 1-Temperature of the warehouse should be less than 52 degrees centigrade and preferably less than 15 degrees.
- 2- Gaskets should not be exposed to the direct sunlight, intense artificial lights or UV.
- 3- Ozone is harmful for rubber; there should not be ozone-producing tools such as Mercury-Vapor lamp in warehouse.
- 4- Gaskets should be kept away from high-voltage electrical devices, electrical motors and devices having static electricity discharge.
- 5- Gaskets should not be under tension or pressure.
- 6- Gaskets should be kept clean.

Self-Anchoring Gasket

The Tyton Self-Anchoring Gasket is a new generation of Tyton gaskets that is equipped with a locking system made of chromed steel, which, when installing the pipes, its teeth engage in the pipe body and lock the joint and maintain its flexibility. The efficiency and safety of pipelines are significantly improved at the lowest cost.

Such gaskets can even be a suitable replacement for cement blocks or common gland joints.

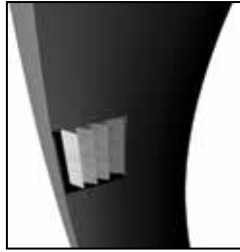

Applications

- :: Suitable for all soils and grounds, especially areas with loose and unstable soil.
- :: Replacement of cement blocks and usual bolted-gland joints.

Advantages

- :: Quick and easy installation, similar to Tyton washers
- :: Lower cost than cement block and bolted-gland pipes



Self-anchoring gaskets can be used to seal and tighten the pipes of Hamoun Nyzeh company, size DN80-DN250 with a pressure of 25 bar and size DN300-DN400 at a pressure of 16 bar.

Rubber gasket for L.Pipe

L.Pipe rubber gasket is designed in a way that is compatible with polymeric pipes. The special design of these gaskets makes the best sealing in the place of joint.

These gaskets are designed and manufactured according to international standard of ISO 4633.

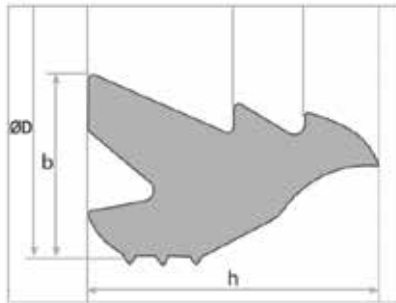

DN.OD	D (mm)	b (mm)	h (mm)	m (Kg)
90	115.5	12.8	22.2	0.055
110	138.3	14.2	24.2	0.085
125	155.2	15.1	25.5	0.115
140	171.5	15.8	26.1	0.165
160	194.4	17.2	27.8	0.187
200	238.3	19.1	29.2	0.271





HANYCO



The HANYCO Manhole Cover with yellow epoxy paint

Manhole

:: Introduction

Manhole is generally used for cleaning, inspection and checking equipment, periodical maintenance, etc. The circular metal plates that are seen in streets are manhole lids. The most important function of manholes is to provide access point for different sections of the sewage network. Also, they are used to access underground cables in telecommunication systems.

Manholes are typically made of ductile or cast iron, concrete, composite, etc. Given the long lifespan of ductile iron, it is considered as one of the most cost-effective materials. Manholes are classified based on the applied force on them and the condition of usage.

One of Hanyco's products is Manhole made of ductile iron manufactured by a fully automatic lost foam casting production line. These manholes are designed and examined based on the simulations by finite element software and performance tests according to national and international standards.

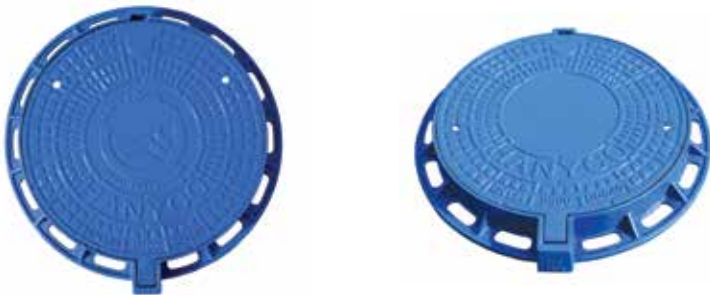

Application

The appropriate class of a manhole top or a gully top to be used depends on the place of installation. Various places of installation have been divided into groups numbered 1 to 6, as listed below.

Group 1 (A Class): Areas that can only be used by pedestrians and pedal cyclists. (Maximum force allowed: 15 KN)

Group 2 (B Class): Pedestrian areas and comparable areas, car parks or car parking decks. (Maximum force allowed: 125 KN)

Group 3 (C Class): For gully tops, installed in the area of kerbside channels of roads which, when measured from the kerb edge, extends a maximum of 0,5 m into the carriageway and a maximum of 0,2 m into the pedestrian area. (Maximum force allowed: 250 KN)

Group 4 (D Class): Carriageways of roads (including pedestrian streets), hard shoulders and parking areas, for all types of road vehicles. (Maximum force allowed: 400 KN)

Group 5 (E Class): Areas imposing high wheel loads, e.g. docks, aircraft pavements. (Maximum force allowed: 600 KN)

Group 6 (F Class): Areas imposing particularly high wheel loads, e.g. aircraft pavements. (Maximum force allowed: 900 KN)

It is noteworthy that HANYCO produces ductile iron manhole in two different classes C250 and D400.

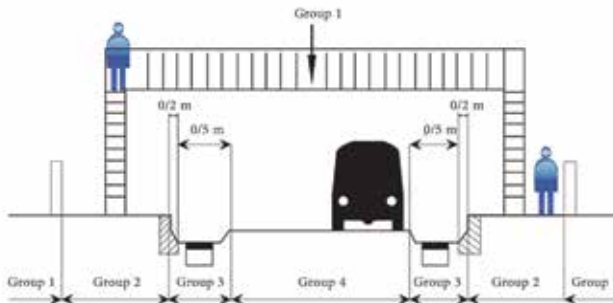

Group 5&6 are used at anchorages, harbour and airports.

Manhole Standards

1- EN124-1: 2015: Gully tops and manhole tops for vehicular and pedestrian areas: "Part-1: Definitions, classification, general principles of design, performance requirements and test methods".

2- EN 124-2:2015: Gully tops and manhole tops for vehicular and pedestrian areas: "Part-2: Gully tops and manhole tops made of cast Iron".

3- Iran national standard INSO 14976, "Gully tops and manhole tops for the vehicular and pedestrian area".

Technical specification of ductile iron manhole tops

Class	Frame internal diameter	Frame external diameter	Cover external diameter	Cover height	Frame Height
C250	647	790	644	70	80
D400				90	

* All dimensions in mm

Advantages of ductile iron manhole

- :: Suitable for use in regions with harsh environmental conditions
- :: Suitable for regions with high traffic loads and high-speed transportation.
- :: Long service life and high strength.
- :: High resistance against corrosion
- :: Adequate resistance against shock.
- :: A green product with high scrap value

Product safety

To increase the product safety while the top is closing, it has been designed in a way that it closes to about 60° and then halts. To fully close the lid, it should be pulled forward and fully closed. This mechanism prevents the sudden fall of the lid and the user's injury. The pin of hinge is welded to the manhole's frame body to minimize the possibility of theft.

Shock and noise damper gasket

HANYCO's Ductile iron manhole tops are equipped with a shock and noise damper gasket.

— | **Wafer Type Butterfly Valves**





HANYCO



Wafer Type Butterfly Valves

The new product of Hanyco is Ductile Iron Wafer-type butterfly valves with the following specifications produced by the "Lost Foam Casting" process in a fully automatic production line.

:: Nominal size: DN50-DN 200 mm

:: Working pressure: PN 16 bar

Application

The Hanyco butterfly valve can be used for a wide range of applications including cold and drinking water as well as general industrial applications up to 120 °C and air conditioning installations to isolate or regulate the water flow. Thanks to numerous material options for the valve's disc and seal, special application cases can also be realized without any problems. They are available in nominal sizes from DN50 to DN200 with Working Pressure 10.16 bar.

The use of butterfly valves on transmission lines as a flow controller is not permitted and must be fully open or fully closed. The design of the valve is such that the disc is fully centered in the open position and provides the best conditions for the flow with the lowest pressure loss.

This valve is suitable for installation between flanges which prepared accordance with DIN EN 1092-2 and operating pressure up to 16 bars.

Special Features

- :: Licensed based on Iranian standard mark application ISIRI 4841
- :: Valve design based on the BS EN 593
- :: Valves flanges face to face based on the DIN EN 558-1 Series 20
- :: Valves flanged dimensions according to DIN EN 1092-2
- :: Sealing capability in both directions
- :: Capability to install in all directions (horizontal, vertical and angular)
- :: Manual operation by lever (standard equipment up to DN150) or by gearbox and hand wheel for DN200
- :: The capability of pneumatic or electric actuator installation on the valve
- :: No need for sealing gaskets between flanges
- :: Performance tests and Inspection according to DIN EN 12266-1

Hydrostatic tests according to DIN EN 12266-1

PN (bar)	Hydrostatic Pressure (bar)	
	Seat	Body
10	11	17
16	17.6	25

Coating Specification

All interior and exterior surfaces of the valves body are coated by electrostatic pure epoxy resin paint (RAL 5005 or RAL 5015), Layer thickness at least 250 µm and certified by reputable international organizations for use in drinking water.

Material

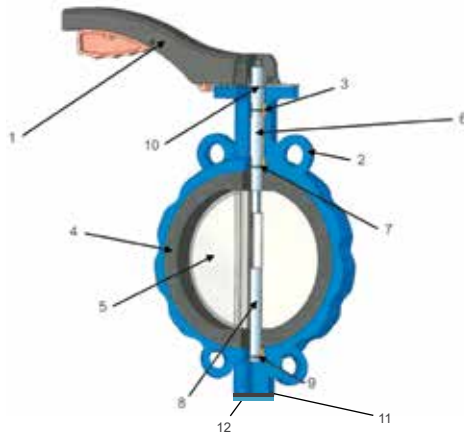

Item Number	Material . Standard	Name of Piece	Spare part
1	Aluminium	Lever	
2	EN-GJS-400-15 *	Body	
3	Brass . PTFE	Bush	+
4	EPDM (NBR on Request)	Liner	
5	AISI 316 (Ni-Plated ductile iron on request)	Disc	
6	AISI 304	Stem (Long)	
7	NBR	O-ring	+
8	AISI 304	Stem (Short)	
9	NBR	O-ring	+
10	DIN 472	Retaining ring	
11	NBR	Washer	+
12	Aluminium	Plug	+

*EN-GJS-500-7 is available based on request.

Lever control wafer-type butterfly valve dimensions & weights

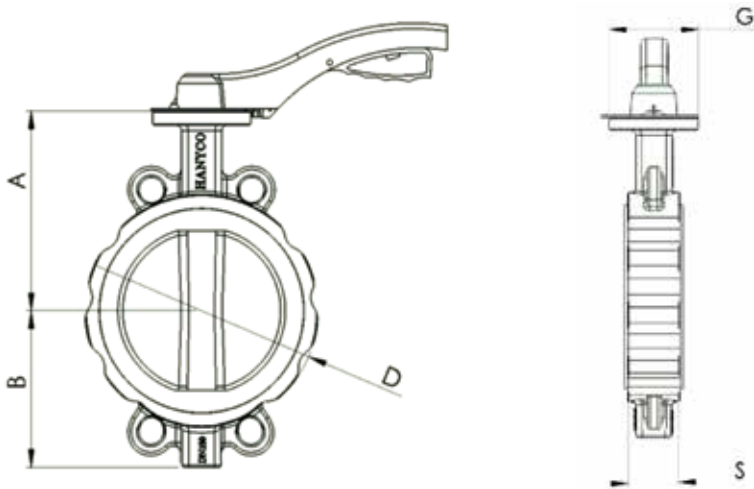

DN mm	A mm	B mm	D mm	G mm	S mm	Flange
50	120	74	97	65	40	F05
65	132	86	111	65	43	F05
80	135	97	127	65	45	F05
100	156	116	159	90	51	F07
125	171	135	184	90	53	F07
150	184	150	214	90	53	F07
200 H	236	180	265	125	58	F07
200 G	236	180	265	125	58	F07

Hamoun Nyzeh Company has the capability of producing wafer-type butterfly valves in DN50- DN150 mm with lever and in DN200 mm with lever (200H) or gearbox (200G).

***Guide for unloading, storing
and loading ductile iron pipes***





HANYCO



HANYCO production site with green belt of Olive trees

Manual of unloading, storing and loading of ductile iron pipes

Although the ductile cast iron pipes have unique characteristics such as high stability, resistance against shock, etc, improper transportation and storage could lead to damage to them.

The following information is collected and presented by Hamoun Nyzeh Company and it is hoped that reading these instructions carefully and observing them helps prevent from any probable and unwanted damages.

Special metal hooks with rubber cover are used for the purpose of lifting and moving the pipes.

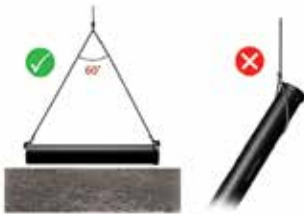

A double wire rope with the angle less than 60 degrees is used to lift the pipes and a single wire should not be used while moving pipes. It should be noted that pipes must be parallel to the ground.

It is necessary to check out the wire ropes from time to time. Using worn out and damaged wires is forbidden and they should be proportional to the weight of pipes.

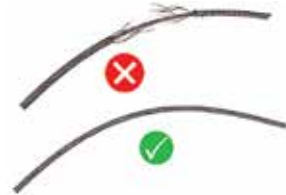



All workers are obliged to use safety equipment such as shoes, gloves, etc.

Swinging or hitting pipes while moving is absolutely forbidden.



Standing under moving pipes and boxes is forbidden.

Loading

Trucks and trailers used for the purpose of safe shipment of pipes should have steel stakes on both sides and adequate number of wooden boards should be placed on the surface of trucks. It should be mentioned that in case the trailer's wooden deck is in good condition, no boards are needed any more.

Be sure to place high-quality, resistant wood under pipes. Also some wedges could be used to secure the pipes. The height of wedges should be proportional to dimensions of sockets.



When loading is completed, pipes are secured using metal chains and wire ropes or in certain cases by a silk belt. To avoid any damage to the external body of pipes, certain amount of carpet is placed between the belt and pipes. It should be noted that for maximum protection in each row, upper and lower pipes should be placed reversely.



Unloading

- :: Make sure pipes are unloaded from the top and then equally from both sides.
- :: Wooden wedges should not be removed until the end of unloading phase so that the pipes will not be damaged in case of probable tilt of the truck.
- :: Pipes should not be tossed or dropped.



Storage

- :: All pipes should be placed parallel.



- :: Prior to storage of pipes, make sure the surface is clean and flat. Note that the floor is not wet, unstable or rocky or does not contain corrosive materials. Prior to arrangement of pipes, use two stable quadrilateral pieces of wood with proper height in parallel form so as to control the weight of pipes and prevent them from touching the ground.

Pipe Arrangement

:: To prevent any pressure on pipes, sockets should not be placed between pipes. The best form of arrangement is when sockets and spigots are laid together one after another.



:: Arrangement of pipes in a warehouse is done in three ways as shown below:



Square arrangement



Uniform arrangement

Pyramidal arrangement



:: In the following table, the maximum number of allowed rows for storage based on pipe length and square arrangement are given. It is recommended that ductile cast iron pipes be arranged using square arrangement. Using pyramidal arrangement is permitted for bigger sizes DN200 and lower height in less sloppy levels. In case of using uniform arrangement, normal pieces of wood with a certain height should be used so that the sockets of each row do not touch the other rows.

In case of delivering pipes in package, purchaser should use a forklift corresponding to the volume and weight of the package. Packages should be moved safely one at a time.

Storage and transportation of light pipes should be carried out in package.

Should you need more technical information for the purpose of other types of arrangement, contact Hanyco's experts.

Permitted number of ductile cast iron pipes for the purpose of storage in square arrangement

Size	Ductile cast iron Class C (non-Preferred)			Ductile cast Iron K9 or Class C (Preferred)		
	Total	Number of floors	Number in each row	Total	Number of floors	Number in each row
80	900	18	50	1100	22	50
100	720	18	40	880	22	40
125	450	15	30	600	20	30
150	450	15	30	600	20	30
200	312	13	24	432	18	24
250	260	13	20	300	15	20
300	136	8	17	204	12	17
350	120	8	15	150	10	15
400	78	6	13	117	9	13
450	72	6	12	84	7	12
500	55	5	11	77	7	11
600	36	4	9	45	5	9
700	24	3	8	32	4	8
800	21	3	7	28	4	7
900	18	3	6	24	4	6
1000	15	3	5	20	4	5
1100	10	2	5	15	3	5
1200	8	2	4	12	3	4

To prevent the creation of ovality in the spigot of the pipes with sizes DN900 to DN1200, during storage and transportation, two wooden pieces should be placed in this area in the form of a cross or a plus. The length of these wooden pieces should be equal to the inner diameter of the pipe, considering the Internal cement coating. After placing them in the spigot area, they should be secured together by tying them with metal wire or hammering nails.

Loading and shipping ductile cast iron pipes to the customer's site is performed either with or without package. Information about the maximum number of ductile cast iron pipes is provided in the table below.

DN	Means of transportation	Pipe
80	6 wheeled truck	180
	6 wheeled truck	140
100	10 wheeled truck	130
	6 wheeled truck	110
150	10 wheeled truck	90
	6 wheeled truck	70
200	10 wheeled truck	60
	6 wheeled truck	50
250	10 wheeled truck	54
	6 wheeled truck	45
300	Truck Trailer	40
350	Truck Trailer	28
400	Truck Trailer	28
500	Truck Trailer	20
600	Truck Trailer	12
700	Truck Trailer	12
800	Truck Trailer	10
900-1200	Truck Trailer	6

Using pyramidal arrangement is permitted for bigger sizes DN200

Allowed number of pipes in a package (Size)		
DN	R.J. Pipe	Tyton Pipe
80	49	60
100	42	56
150	30	36
200	24	25
250	15	20
300	15	15
350	8	12
400	8	8 or 12
500	6	6
600	3	3
700	3	3
800	2	2
900-1000	-	2

* It is not possible to packpipes for DN1000 and above.

Allowed number of light pipes in a package (Size)	
DN.OD	light pipe
90	48
110	42
125	42
160	30
200	30

It is noteworthy that it is only possible to load four packages in each step.



Manual of installation and operation





HANYCO



DN150 Q.R flex pipe deflection during the installation

Installation Guide

This part contains all the necessary activities required to prepare working conditions and subsequent operations such as transporting pipes, fittings and components m to trenches, pipe threading, trench excavation, piping and installation completion, workshop test (working pressure), disinfection and pipeline operation.

This information is merely collected as a guide to install ductile cast iron pipes and based on existing standards. However, contractor is obliged to perform based on the employer's instructions and other supplementary engineering instructions of counselor and other contract regulations.

Preparation of the piping route

Prior to the start of operations and for the purpose of pipe threading and digging the trench according to the operational map, the piping route should be investigated and all the physical obstacles ought to be identified and removed. In certain cases such as cutting down trees and passing through gardens, destroying city buildings and facilities, etc. necessary permissions should be obtained.

Urban facilities such as gas transmission lines, pipe lines, water, sewage and telephone, etc. should be marked prior to the excavation based on existing maps and required arrangements should be made accordingly.



DN100 R.J.pipe installation at Tehran

Trench Excavation

Trench excavation means to excavate and create a proper channel in any types of ground for the purpose of installation of pipes. In case certain arrangements need to be made based on the technical specifications of land, contractor is obliged to consider all the safety instructions while excavating the trench.

Trench Width

The minimum width of trench depends on the type and width of the pipe, depth of trench, texture and type of the ground. If the width of trench is not specified in the plan, a distance of 40 cm between pipe and wall of trench is recommended for backfilling around the pipe.

Trench Depth

The depth of a pipe trench is mentioned in operational maps and specifications. The depth of piping tranche is a function of ground status, frost depth, type and diameter of the pipe, applied loads and other hydraulic and technical considerations.

Backfilling around ductile cast iron pipes

A. Ductile cast iron pipes Class K9

Backfilling around ductile cast iron K9 class is different depending on the working pressure and depth of the trench and is classified in five different categories:

TYPE 1 The pipe is laid on the smooth trench and without any bedding. No particular backfilling is performed around the pipe.

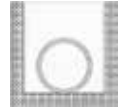

TYPE 2 The pipe is laid on the smooth trench and without any bedding. The soil around the pipe is relatively compacted up to the height of the middle of the pipe.



TYPE 3 The pipe is laid on a layer of smooth soil with the height of 10 Cm. The soil around the pipe is compacted up to the height of the pipe crown (top).

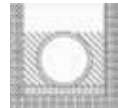

TYPE 4 The pipe is laid on a mixed layer of soil and sand with the thickness of 10 Cm. Granular materials are poured around the pipe up to the top of the pipe and is 80% compacted according to AASHTO T-99 standard.

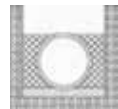

TYPE 5 A layer of granular materials with the thickness of 10 cm is poured from under the pipe up to the height of top of the pipe (crown) and is 90% compacted according to Proctor, AASHTO T-99.



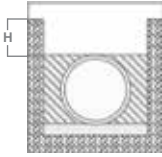

Minimum backfilling required for ductile cast iron pipes per trench depth (considering traffic load)

DN																H (M)
1200	1100	1000	900	800	700	600	500	400	350	300	250	200	150	100		
Type1	Type1	Type1	Type1	Type1	Type1	Type1	Type1	Type1	Type1	Type1	Type1	Type1	Type1	Type1	Type1	0.5
Type1	Type1	Type1	Type1	Type1	Type1	Type1	Type1	Type1	Type1	Type1	Type1	Type1	Type1	Type1	Type1	1
Type1	Type1	Type1	Type1	Type1	Type1	Type1	Type1	Type1	Type1	Type1	Type1	Type1	Type1	Type1	Type1	1.5
Type1	Type1	Type1	Type1	Type1	Type1	Type1	Type1	Type1	Type1	Type1	Type1	Type1	Type1	Type1	Type1	2
Type1	Type1	Type1	Type1	Type1	Type1	Type1	Type1	Type1	Type1	Type1	Type1	Type1	Type1	Type1	Type1	2.5
Type1	Type1	Type1	Type1	Type1	Type1	Type1	Type1	Type1	Type1	Type1	Type1	Type1	Type1	Type1	Type1	3
Type1	Type1	Type1	Type1	Type1	Type1	Type1	Type1	Type1	Type1	Type1	Type1	Type1	Type1	Type1	Type1	3.5
Type1	Type1	Type1	Type1	Type1	Type1	Type1	Type1	Type1	Type1	Type1	Type1	Type1	Type1	Type1	Type1	4
Type1	Type1	Type1	Type1	Type1	Type1	Type1	Type1	Type1	Type1	Type1	Type1	Type1	Type1	Type1	Type1	4.5
Type1	Type1	Type1	Type1	Type1	Type1	Type1	Type1	Type1	Type1	Type1	Type1	Type1	Type1	Type1	Type1	5
Type3	Type3	Type3	Type3	Type3	Type3	Type3	Type3	Type3	Type3	Type3	Type3	Type3	Type3	Type3	Type3	5.5
Type3	Type3	Type3	Type3	Type3	Type3	Type3	Type3	Type3	Type3	Type3	Type3	Type3	Type3	Type3	Type3	6
Type5	Type5	Type5	Type5	Type5	Type5	Type5	Type5	Type5	Type5	Type5	Type5	Type5	Type5	Type5	Type5	7
Type5	Type5	Type5	Type5	Type5	Type5	Type5	Type5	Type5	Type5	Type5	Type5	Type5	Type5	Type5	Type5	8
Type5	Type5	Type5	Type5	Type5	Type5	Type5	Type5	Type5	Type5	Type5	Type5	Type5	Type5	Type5	Type5	9
Type5	Type5	Type5	Type5	Type5	Type5	Type5	Type5	Type5	Type5	Type5	Type5	Type5	Type5	Type5	Type5	10

Type1 Type2 Type3 Type4 Type5

B. Ductile cast iron pipes Class C

Backfilling around ductile cast iron C class is different depending on the working pressure and depth of the trench and is classified in five different categories:

TYPE 1 The pipe is laid on the smooth trench and without any bedding. No particular backfilling is performed around the pipe.



TYPE 2 The pipe is laid on the smooth trench and without any bedding. The soil around the pipe is relatively compacted up to the height of the middle of the pipe.



TYPE 3 The pipe is laid on a layer of smooth soil with the height of 10 Cm. The soil around the pipe is compacted up to the height of the pipe crown (top).

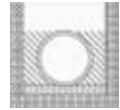

TYPE 4 The pipe is laid on a mixed layer of soil and sand with the thickness of 10 Cm. Granular materials are poured around the pipe up to the top of the pipe and is 80% compacted according to AASHTO T-99 standard.

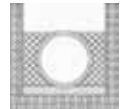

TYPE 5 A layer of granular material with the thickness of 10 cm is poured on the pipe up to the height of top of the pipe (crown) and is 90% compacted according to Proctor, AASHTO T-99.



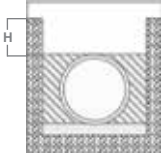

Minimum backfilling required for ductile cast iron pipes per trench depth (considering ing traffic load)

C50					H (M)	C40					H (M)				
DN						DN									
300	250	200	150	100		600	500	400	350	300	250	200	150	100	
					0.5										0.5
					1										1
					1.5										1.5
					2										2
					2.5										2.5
					3										3
					3.5										3.5
					4										4
					4.5										4.5
					5										5
					5.5										5.5
					6										6
					7										7
					8										8
					9										9
					10										10

Type1 Type2 Type3 Type4 Type5

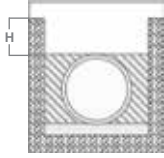

Minimum backfilling required for ductile cast iron pipes
per trench depth (considering ing traffic load)

C30										H (M)
DN										
1200	1100	1000	900	800	700	600	500	400	350	
										0.5
										1
										1.5
										2
										2.5
										3
										3.5
										4
										4.5
										5
										5.5
										6
										7
										8
										9
										10

Type1 Type2 Type3 Type4 Type5

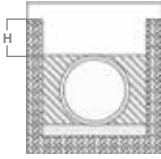

Minimum backfilling required for ductile cast iron pipes per trench depth (considering ing traffic load)

C25										H (M)
DN										
1200	1100	1000	900	800	700	600	500	400	350	
Type4	Type4	Type4	Type4	Type4	Type5	Type5	Type5	Type5	Type5	0.5
Type2	Type2	Type2	Type2	Type2	Type2	Type2	Type2	Type2	Type2	1
Type2	Type2	Type2	Type2	Type2	Type2	Type2	Type2	Type2	Type2	1.5
Type2	Type2	Type2	Type2	Type2	Type2	Type2	Type2	Type2	Type2	2
Type2	Type2	Type2	Type2	Type2	Type2	Type2	Type2	Type2	Type2	2.5
Type2	Type2	Type2	Type2	Type2	Type2	Type2	Type2	Type2	Type2	3
Type2	Type2	Type2	Type2	Type2	Type2	Type2	Type2	Type4	Type4	3.5
Type4	Type4	Type4	Type4	Type4	Type2	Type4	Type4	Type4	Type4	4
Type4	Type4	Type4	Type4	Type4	Type4	Type5	Type5	Type5	Type5	4.5
Type5	Type5	Type5	Type4	Type4	Type5	Type5	Type5	Type5	Type5	5
Type5	Type5	Type5	Type5	Type5	Type5	Type5	Type5	Type5	Type5	5.5
Type5	Type5	Type5	Type5	Type5	Type5	Type5	Type5	Type5	Type5	6
Type5	Type5	Type5	Type5	Type5	Type5	Type5	Type5	Type5	Type5	7
Type5	Type5	Type5	Type5	Type5	Type5	Type5	Type5	Type5	Type5	8
Type5	Type5	Type5	Type5	Type5	Type5	Type5	Type5	Type5	Type5	9
Type5	Type5	Type5	Type5	Type5	Type5	Type5	Type5	Type5	Type5	10

C20							H (M)
DN							
1200	1100	1000	900	800	700		
Type5	Type5	Type5	Type5	Type5	Type5	Type5	0.5
Type2	Type2	Type2	Type2	Type2	Type2	Type4	1
Type2	Type2	Type2	Type2	Type2	Type2	Type2	1.5
Type2	Type2	Type2	Type2	Type2	Type2	Type2	2
Type2	Type2	Type2	Type2	Type2	Type2	Type4	2.5
Type4	Type4	Type4	Type4	Type4	Type4	Type4	3
Type4	Type4	Type4	Type4	Type4	Type4	Type4	3.5
Type5	Type5	Type5	Type4	Type4	Type5	Type5	4
Type5	Type5	Type5	Type5	Type5	Type5	Type5	4.5
Type5	Type5	Type5	Type5	Type5	Type5	Type5	5
Type5	Type5	Type5	Type5	Type5	Type5	Type5	5.5
Type5	Type5	Type5	Type5	Type5	Type5	Type5	6
Type5	Type5	Type5	Type5	Type5	Type5	Type5	7
Type5	Type5	Type5	Type5	Type5	Type5	Type5	8
Type5	Type5	Type5	Type5	Type5	Type5	Type5	9
Type5	Type5	Type5	Type5	Type5	Type5	Type5	10

Type1 Type2 Type3 Type4 Type5

Installation C-Class pipes

Installation Guide

When installing C-class pipes, in addition to considering the type of embankment, the following items must be considered.

1. Whether the soil around the pipe should be compacted or not, this term is used: "soil is relatively compacted" (for instance the soil compaction type 2). In high-compacted soils (such as proctor and AASHT09), it should be noted that firstly the initial soil should be layered around the pipe. Consequently, depending on the compaction required, each layer of soil will be compacted using compactor excavator. Afterwards, the next layer will be charged into the trench.

To this aim, considering the dimensions of excavator, the dimensions of trench should be removed in a way that it will be layered while filling the trench. In addition, the same excavator is used to move and direct the soil toward the beneath of pipe.



2. It should be noted that if the soil required to fill the trench is suddenly poured into it and then compacted, the space beneath the pipe will remain empty or the soil will not even be compacted. As a result, as soon as the final filler soil is added to the trench, the presence of this empty space beneath the pipe leads to reshaping the cross-section in pipe from round to oval. It can also lead to the increase in the width of the spigot at its joint with socket. This will consequently result in leakage of pipe in a short time (during pipeline hydrostatic test) or long term (Following the traffic load).

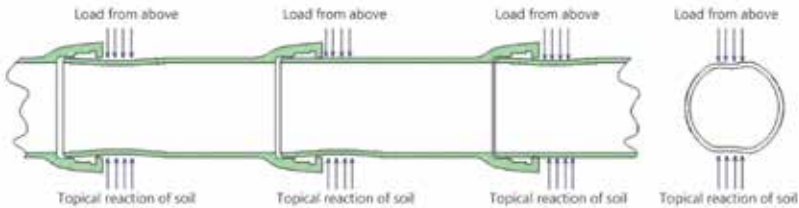
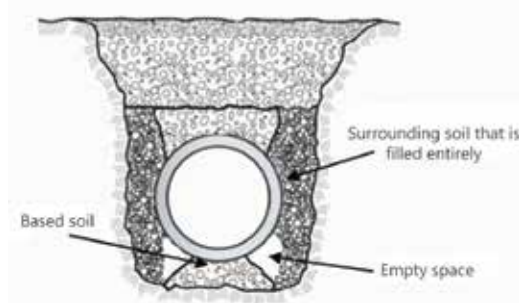

3. In cases where it is not possible to widen the trench and the soil around the pipe needs to be compacted (even relatively and partially), some granular materials such as pea gravel (6-12 mm and round shape) should be used beneath the pipe and in the trench, so that a reasonable section of the pipe's external surface is covered by such materials (table1). Consequently, the rest of backfilling process and soil-compaction are performed according to the type mentioned in Catalogue. If the filling of trench is performed following the pipe assembly, it should be noticed that the section beneath the pipe is in contact with the mentioned granular materials. In other words, the beneath of pipe should be fully filled with granular materials.

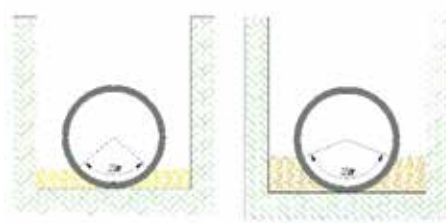

E' (Mpa)	2α (Degree)	Filling & Compacting
1	30	Type 1
2	45	Type 2
2.75	60	Type 3
3.5	90	Type 4
5	150	Type 5

E' : Modulus of soil reaction

In this method of bedding, we can make certain that there will not be any empty space remaining beneath the pipe and it will not deform as a result of pressure and non-compacted soil.

In cases where it is possible, have worker use Vibration devices (with width less than 20-30 cm) to compact the soil around the pipe.



4. In cases where the depth of trench is more than 2 meters and the soil of the region is prone to falling while using manual compactor, in addition to using granular materials on pipe bedding mentioned in part 3, it is also possible to connect compactors to excavator for the purpose of soil compaction.

For this reason, the width of trench should correspond the compactor's dimensions.

5. In cases where it is not possible to use soil-compacting tools, granular materials as well as a wide trench, and the project operator intends to use plastic materials such as concrete, soil-cement mixture, etc., corresponding considerations should be taken into account following the pipe assembly and prior to charging the filler soil into the trench. What is important here is that, following the filling of trench using plastic materials, we must make sure that they become dry and stable. For this reason, at the joint of spigot and socket certain holes should be excavated with the depth of trench. Their stability (holes) should be controlled depending on the used materials and using controlling measures.

In case where the filling is performed before the materials becomes stable and dry, the pipe spigot will increase in width particularly at the joint with socket leading to a weak sealing and leakage as well. Moreover, if the filler soil is not layered in the trench, the same result will be brought about.

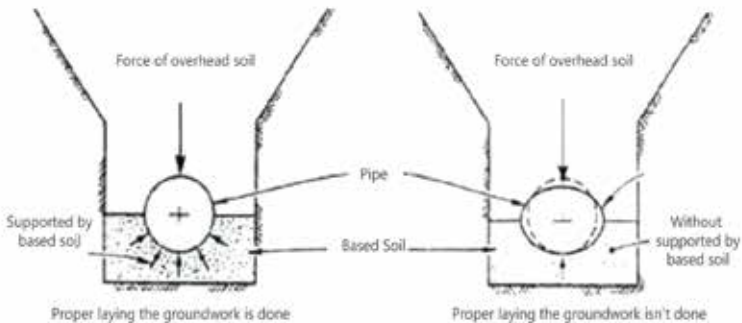

If embankment is applied on the pipe before the rigidity and drying of the material, this action will lead to ovality of the pipe, especially at the junction of the spigot and the socket, which will ultimately prevent sealing and cause leakage of the pipe. Also, if the filler soil is not charged in layers inside the trench, it will have the same result.

6. For pipes bigger than DN 400 size, it is suggested to use the soil-compaction 2 or stronger.

7. “Soil must be relatively compacted” in the table of soil-compaction means that, following the soil compaction, its reaction module reaches the expected limitation. This amount is shown in table 1 of this guide for different types of soil compaction as the soil reaction module with Parameter E.

It is evident that prior to the commencement of pipeline operations, the mechanical specifications of soil including humidity- density should be obtained for the optimized compaction of soil. Therefore, performing the soil compaction while the humidity of soil is not suitable could lead to the weak stability of pipe bedding. In cases where the humidity of soil is more than the expected amount, it is much probable that pipes get out from soil in case of bending in pipeline.

If the soil compaction instruction is not observed, lack of pipe sealing could occur in trenches not as deep as the required amount for soil compaction.

In case a region’s soil is not compactable or there is no solution but digging deep trenches or passing through traffic loads is inevitable, it is necessary to consult with experts of this company to choose the proper working class of pipe as well as the proper condition for creating trench.

Transportation of Pipe and Components to the installation Site and Commission (Threading)

Contractor could refer to the "Guide to unloading, storage and loading the ductile cast iron pipes" of this catalogue, in order to obtain the right instructions regarding shipping and unloading. Moreover, considering the external cover of pipes, avoid placing them directly on the ground. In this case, it is possible to use wooden boards. Contractors should plan in a way that prevents from long threading of pipes. Therefore, pipe threading in urban regions is performed in line with the speed of piping. Moreover, certain measures should be taken to prevent from moving pipes to mountainous and sloppy regions.

To prevent from entering soil and other materials to the pipes while threading, it is required to put caps on the pipes following the excavation operation so that no pollutions or animals can get into the pipes. For the purpose of facilitation the piping operation, pipes should be threaded in a way so that the socket is placed towards the piping direction.

Examination before installation

1) Ductile cast iron pipe

The appearance quality of the pipes and fittings should be visually inspected before installation. Any physical damage to the external and internal coating, ovality and dirt inside the pipes should be carefully inspected, it And if necessary, it should be repaired according to the relevant standard.

According to the standard, it is allowed to repair the damaged area of the cement coating inside the pipes (which may occur during the carrying and moving of the pipes). By observing the presence of defects in the cement coating of pipes or fittings, their bodies must be checked for possible damages. If only the cement coating is damaged, it can be repaired according to the following instruction.

Repair Materials And Tools

Portland cement, concrete glue, silica sand, white cement, water, Hammer, Chisel, wire brush, paint brush, mortar preparation container, trowel, nylon, old cloth, adhesive tape.

Steps

1- Remove the damaged area of the cement coating using a hammer, Chisel and wire brush completely up to the metal surface inside the pipe or fitting. The edges must be completely vertical to the inner surface of the pipe or fitting. Clean the area that will be in contact with the mortar.

2- Prepare a stiff mortar including four parts of Portland cement, five parts of sand, one parts of concrete glue and two parts of water.

3- Apply concrete glue to the damaged area with a paint brush.

4- With a trowel, apply the mortar on the desired area and smooth its surface to the thickness of the cement wall. Then wait for the mortar to harden. Then smooth the surface of the new cement mortar with an old cloth.

5- Cover the repaired portion with a wet towel or wet paper, then seal up with plastic film and adhesive tape and keep it in this state for 24 hours.

6- Make a grout mortar by combining one part of cement, two parts of white cement, six parts of water and one part of concrete glue and apply it to the restored surface, then allow it to dry. In order to improve the appearance of Allowed cracks in the cement coating, this grout can also be used.

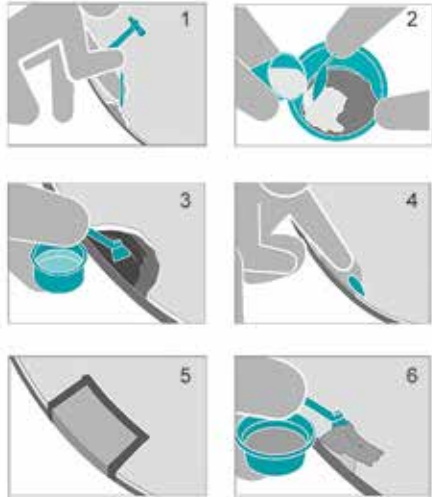

Repair Of External Coating

If the external coating of the pipes is damaged, it must be repaired. The method of repairing the external coating is as follows and using the tools in Figure 1.



1-First, any dirt and rust must be removed from the damaged area. For this purpose, you can use a wire brush and sandpaper and then clean the desired surface with a cloth

(Figure 2).

2- Apply zinc rich paint on the cleaned area. This paint should not be applied on a wet surface or a surface with previous bitumen paint (Figure 3).

3-Then, using a paint brush and bitumen paint, repair the damaged area and give enough time for the paint to dry (Figure 4).



:: Do not apply coating when the pipe surface is wet.

:: The coated surface has to be completely dried before installation.

:: Paint and thinner must be protected from fire because they are highly flammable.

2) Sealing Gasket:

Prior to installation operation, it is necessary to examine sealing gaskets to ensure they do not have any cracks, tears and cuts. Moreover, rubber gaskets should be kept indoors. They should not be exposed to sunlight or any types of UV. They should also be kept in a cool place.

Duration of storing gaskets in warehouse should be as short as possible. As long as all the storing requirements are observed, up to 3 years after fabrication, gaskets maintain their desirable quality.

Installation Guide



:: Firstly, thoroughly clean the grooves on socket and spigot using a smooth brush.



:: After making a point of cleaning sockets and lubricating them with a proper soap-based lubricant, start the assembly operation by placing a gasket which matches the size and type of pipe.

:: Pick the proper gasket matching with the type and size of the pipe. By making a curve or ring in the gasket fix it in its proper place.

:: For pipes with diameter more than 500 mm, you'd better make two curves or rings in the gasket. Make sure that the gasket is placed in its proper groove.



:: Following making the proper bevel on the spigot, place two pipes in the same direction (according to the producer's instruction) and if necessary use a suitable wedge to do so.

**Instructions on installation of RJ Pipe
(anti-seismic flexible restrained joint):**

Firstly, remove the insulated wire (gland keeper) used to fix the gland on spigot as well as safe transportation of pipe and components from the gland. Then, remove and clean any pollutions and external materials from the end of the spigot, socket internal wall and gland internal wall using a brush.



:: After cleaning the socket and lubricating it with a proper soap-based lubricant, start the assembly operation by placing the fitting gasket.



:: Lubricate the inner part of the socket and tip of the spigot again using a lubricant.



:: Place the end of the spigot on which the locking ring is welded with the proper distance in to the socket so that both pipes are in the same direction (use a proper wedge if required) and assemble both pipes by applying a uniform pressure preferably using proper tools such as crowbar or mechanical winches.



:: Move the gland toward the spigot so that its caps are placed on the spigot plugs. Move it toward the spigot and rotate so that its plugs place behind the pipe's caps.

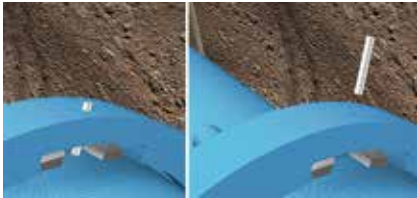

:: Depending on the size of the pipe, three or four holes with certain distances are placed on the gland. After placing the locking rim in its proper place, it is necessary that a split elastic pin is placed inside the hole corresponding the locking rim.

:: It is recommended to place the end of the pin above the external surface of the gland so that the assembly operation becomes easy. For the purpose of preventing the gland from rotating around the socket, proper locking rim should be chosen. One locking rim is adequate.

Proper equipment for assembling the ductile cast iron pipes

For the purpose of assembling the ductile cast iron pipes, it is necessary to use proper equipment such as crowbar (For sizes smaller than DN 80- DN 120) or mechanical winches (for sizes bigger than DN 150, one winch or more depending on the size of the pipe). It should be noted that the allowed assembly pressure is indicated on the spigot using two lines.



Lubricant

During installation at customer site a kind of soap based putty is used to facilitate assembly of pipes that is provided by Hamoun Nyzeh Company. This material is nontoxic, washable, and without destructive effect on the gaskets.

⊗ **Note:** Due to destructive effect of oil based lubricants on gaskets, such material should not be used in assembly of pipes.

Cutting Pipes

Prior to cutting, make sure the “scissors” sign is marked on the pipe (can be cut) (Calibrated pipe). It is not recommended to cut the calibrated pipes with more than four meters distance from the spigot head.



Proper equipment for cutting pipes

DN 80-DN 700 size: All types of cutting devices such as stone cutter, shearing machine, guillotine saw, etc.

DN 800-DN 1200 size: Pneumatic cutting saw

Cutting section (Spigot bevel)

In case of cutting the pipes, spigot should be beveled first according to the specifications below:

DN	n	m
100-300	9	2
350-600	9	3
700-1200	15	5

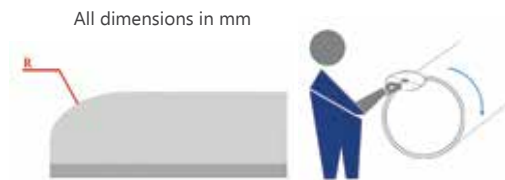

Ovality

In case of improper carrying and storage, ovality might occur in pipes particularly bigger sizes. In this case, pipe assembly might hardly occur and ovality should be prevented prior to the assembly.

Essential equipment for prevention of ovality (400-1200 mm)



- Manual Hydraulic Jack (Number 1)
- Hook and chain (Number 2)
- Chain size and the capacity of the hydraulic jack depend on the pipe size.

Ovality prevention steps

- :: Placing the hydraulic jack as well as necessary equipment on the pipe and fastening the chain in order to create the necessary pressure force
- :: Releasing the chain, removing the pneumatic force and jack from the pipe
- :: Control the equipment performance to prevent from damaging the interior surface
- :: Pipe installation while placing the device in proper place
- :: Precise control of ovality

Guide to welding the RJ. Pipe welding (anti-seismic flexible restrained pipe):

In the event that the RJ Pipe is cut in pipeline for any reason or should the customer buy the pipe without welded ring from producer (while installation), the following guideline could be used for the purpose of welding the locking ring around the spigot of R.J Pipe.

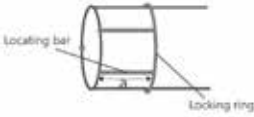
Welding using SMAW method			Welding process	
One- sided welding			Type of fitting	
Thickness	Standard	Type of Cast Iron	Technical characteristics of base metal	
5 to 14 mm	EN-GJS400-15	SG cast iron		
Electrode diameter	ANSI.AWS-A5.15	Type of electrode	Technical characteristics of filler metal	
3.25 mm		ENiFe-CI		
Current polarity		Transitional mode	Electrical characteristics	
DCEP current and electrode are connected to the positive electrode and the minimum .ampere is used		Short Circuit		
Progress speed: 6-3 mm . s	22 to 24 V	75 to 100 A	Welding method	
Welding in horizontal status			Welding status	
			<th>Fitting Scheme</th>	Fitting Scheme
				

Post-welding operations

- :: Cleaning the welded area
- :: Covering the damaged area using a brush (Acknowledged by producer)

Pipeline Hydro test under pressure

The length of pipeline test' section should be considered based on the following criteria:

- :: Environmental condition
- :: Water accessibility
- :: Number of fitting pieces and peripherals
- :: Difference of height between pipeline different parts

Regarding the pneumatic pipeline, the length of test's section should not be more than 1500 meters:

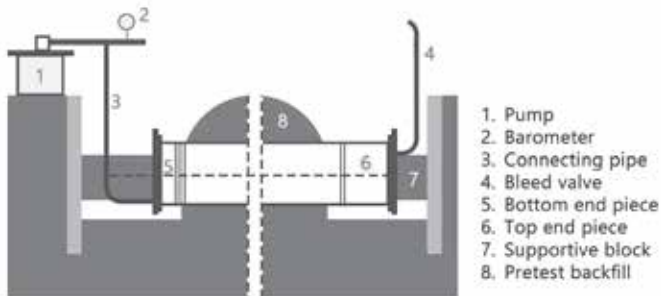

Pipeline Support

All the fittings such as elbows, tees, convertor and flanges should be supported before test using supportive blocks or fittings and supportive facilities.

Segregation and sealing the tested components should be performed using blind flange or other blockers with proper working pressure. If for application reasons, valves are used as a blocker, the test pressure shall not be more than valves' working pressure. While evaluating the total leakage for a part of test, the allowed rate of valves' leakage should be considered.

Backfilling before test

This part of backfilling is generally performed using a proper and acknowledged soil to support the axial forces during the test. Its height is usually 30 cm from the top of the pipe (crown). For diameters bigger than 600 mm, it can be more than 30 cm and based on the characteristics of the scheme.

Pipeline filling

Normally, filling must be performed from the lowest point of the testing area and with the slowest speed to make sure the full air release.

In high points, pipeline should be equipped with air bleeding system. It is recommended that the flow rate is not more than 10% of the designed flow rate while filling.

- ⊗ Pipeline with cement coverage requires a post-filling period of time (depending on the humidity) to absorb water using cement coverage.
- ⊗ Test methods of this part could be only applied for pressure test by water. In addition, pressure test by air is not performed due to safety issues.

Preliminary operations

After filling and prior to the test, keep the testing area under working pressure for adequate amount of time so that it becomes stable in terms of movement of pipe and water absorption by internal coverage.

According to standards, it is recommended that this time shall not be less than 24 hours. Consequently, all the fittings, supports and blockers should be visually examined and repaired if they are damaged (after water release).

Once you have confirmed all conditions, increase pressure steadily to reach the following amount:

:: For working pressure less than or equal 1.5:10 bars working pressure

:: For working pressure less than 10 bars, plus 5 bar

Various types of tests

Pressure decrease test:

Keep the test pressure constant for at least one hour by pumping and precision of ± 0.1 . Consequently, turn off the pump and don't allow more water to enter the testing area at least for following time periods:

:: One hour for $DN \leq 600$

:: Three hours for $600 < DN \leq 1400$

Following these periods, measure the pressure on testing area.

Determine the waste water by measuring the required water for pumping to the testing area for the purpose of returning the pressure to the test pressure with precision of $\pm 1\%$.

Constant pressure test:

Fix the test pressure for at least one hour by pumping and precision of ± 0.1 . Consequently keep the pressure test (± 0.1) in the testing area by pumping for at least following periods:

Test acceptance criteria

The amount of waste water should not be more than 0.001 liter . hour (Pipeline in Km, pipe's nominal size (mm), Static pressure).

:: One hour for $DN \leq 600$

:: Three hours for $600 < DN \leq 1400$

Pipe Disinfection

Upon completion of all the operations and installation of valve and pipes as well as water pressure test, pipe line is disinfected. For this purpose, chloride is added to the water and the remaining chloride should be steadily examined to make sure the concentration of chloride is not less than 25 gram . m³ during 24 hours. During the test, all the valves (On.Off) should be turned on and off several times so that the chloride contacts with all parts of valve.

General washing of pipeline should be done in less than 24 (Maximum 24 hours) hours following the test and disinfection using chloride water with standard concentration of drinking water. Sampling and hygienic test of the water is performed based on the instructions of supervision unit.

For more information you can refer to ANSI.AWWA C 651.

Step by Step guide to Polyethylene sheath installation

:: According to ISO 8180 Standard, two methods have been presented to install polyethylene sheath for both dry and wet trenches.

Sheath installation on dry trench



:: Cut out a part of polyethylene sheath which is 60 cm longer than the pipe length. Fully clean the pipe body. Put the polyethylene sheath from the spigot on, while the pipe is pendant on the air using proper equipment. The polyethylene sheath shall be compacted like accordion in the distance between belt and end of the pipe so that the end of the pipe could be seen.



:: Gradually move the pipe down in to the trench and place the end of the pipe in the previous pipe socket.



:: Move the pipe's supportive belt toward the socket. Keep the pipe at a short distance from trench's bed so that it would be possible to stretch the polyethylene sheath towards socket. Then, stretch the polyethylene layers fully toward the pipe's body.



:: In this step, stretch the previous pipe's polyethylene layer at the joint of the two pipes and tighten it using a special tap in its place.



:: Fold up the additional polyethylene layer on the length of the pipe; and put it on the bottom layer using a tape so that it wouldn't be severely compacted. Consequently, we tighten it with 90 cm of distance using an adhesive tape.



:: In case of probable damage to the polyethylene layer, cover it up using an adhesive. If the damaged area is huge, cover up the area using a polyethylene sheet and seal the edges fully with an adhesive.



:: In order to prevent any damage while filling the trench, it is suggested that polyethylene layer have some relative freedom in the fitting area. The soil used should be devoid of any stones, wood, clod and other materials having adverse impacts on polyethylene layer. While backfilling make sure the equipment does not hit the polyethylene layer.

Sheath installation in a wet trench

:: In wet sheaths, pipe should be covered with polyethylene before entering the trench.



:: Cut the polyethylene sheath 60 cm longer than the length of the pipe. Then, stretch it on the pipe.



:: Stretch the polyethylene sheath on the pipe so that it is 30 cm redundant on both ends.



:: Roll up the additional part on the length of the pipe. Then tighten it using an adhesive tape peripherally with a distance of 60 cm from each other on the body of the pipe, so that the minimum distance between pipe and polyethylene sheath remains.

The first and the last adhesive tape should cause the full sealing of polyethylene layer around the pipe. Then, stretch the compacted section (Accordion) on the head and the end of the pipe and place it on each other at the joint spot.



:: You should be careful that the polyethylene layer would not be damaged while pipe assembly.

Follow the installation steps same as the previous method.

⊗ In order to lift the pipes with polyethylene cover, use covered steel cables or intertwined bands to prevent from damaging the polyethylene layer.



Ductile iron fittings





HANYCO



The fitting production line at lost foam casting workshop(Black area)

Ductile iron fittings

One of the most important elements of a pipeline are fittings as they play a critical role in completion of a pipeline and changing its direction. Access to compatible fittings is considered as one of the main advantages of a pipe which encourages contractors to select and use a certain type of pipe.

HANYCO is the manufacturer of a wide range of fittings from DN 80 to DN 1200 mm by means of Lost Foam Casting (LFC) method with a capacity of 3000 tons per year for the first time in Iran.

Hanyco manufactures various types of fittings including Tyton fittings, R.J.Pipe fittings, Q.R.Flex fittings, L.pipes fittings match to polymeric pipes, Integrated or loosed flange fittings, Bolted gland fittings in all types of tees, Bends, tapers, flanged spigot, flanged socket, etc.

Hamoun Nyzeh Company can produce custom fittings upon customer request.

It is possible to apply various internal and external coatings according to the table below:

Row	Internal lining	External coatings	Standard
1	Anti-sulphate portland cement	Metallic Zinc+ Bituminous paint or liquid Epoxy	ISO 8179
2	High-Alumina cement	Metallic Zinc+ Bituminous paint or liquid Epoxy	EN 598
3	Powder epoxy paint	Powder epoxy paint	EN 14901
4	Powder epoxy paint	Bituminous paint	ISO 8179

For more information about specifications of bolted gland and Integrated or loosed flange fittings, please contact Hanyco's experts.

For other lining and coatings, please contact Hanyco's experts.

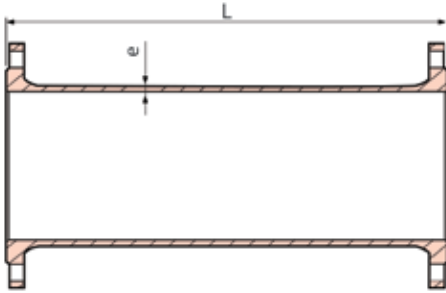

Double flanged ductile iron pipe
(Casting)



DN	e	L
	(mm)	(mm)
80	7	1000
100	7.2	1000
150	7.8	1000
200	8.4	1000
250	9	1000
300	9.6	1000
350	10.2	1000
400	10.8	1000
500	12	1000
600	13.2	1000
700	14.4	1000
800	15.6	1000
900	16.8	1000
1000	18	1000
1100	19.2	1000
1200	20.4	1000

Note1. Maximum length of a one-piece pipe manufactured in casting method is 1000 mm. however, this length can be increased to max. 6000 mm by means of welding at the request of customer.

Note2. All weights have been calculated based on thickness class of K 12. In case you require other classes, please contact technical experts of Hanyco.

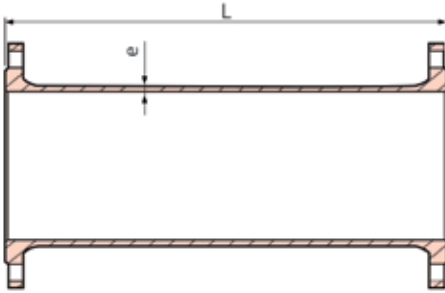

Double flanged ductile iron pipe
(welding)



DN	e	L
	(mm)	(mm)
80	6	1000
100	6	1000
150	6	1000
200	6.3	1000
250	6.8	1000
300	7.2	1000
350	7.7	1000
400	8.1	1000
500	9	1000
600	9.9	1000
700	10.8	1000
800	11.7	1000
900	12.6	1000
1000	13.5	1000
1100	14.4	1000
1200	15.3	1000

Note 1. Production of double welding flanged pipes of various lengths and maximum length of 6000 mm is possible.

Note 2. All weights have been calculated based on thickness class of K9. In case you require other classes, please contact technical experts of Hanyco.

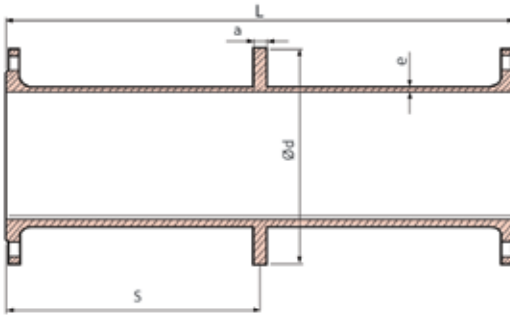

Double flanged ductile iron pipe with puddle
(Casting)

FFM



DN	e	a	L	d
	mm	mm	mm	mm
80	7	16	1000	200
100	7.2	16	1000	220
150	7.8	18	1000	285
200	8.4	20	1000	340
250	9	20	1000	400
300	9.6	20.5	1000	455
350	10.2	20.5	1000	505
400	10.8	20.5	1000	565
500	12	22.5	1000	670
600	13.2	25	1000	780
700	14.4	27.5	1000	895
800	15.6	30	1000	1015

Note 1. Maximum length of a one-piece pipe manufactured in casting method is 1100 mm. however, this length can be increased to max. 6000 mm by means of welding at the request of customer.

Note 2. Parameter S indicates the point where a puddle is set at the order of customers and its tolerance is +/-5.

Note 3. All weights have been calculated based on thickness class of K 12. In case you require other classes, please contact technical experts of Hanyco.

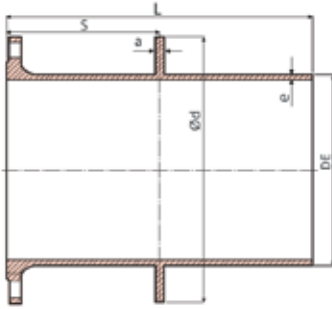

Flanged spigot ductile iron pipe with puddle (Casting)



DN	DE mm	e mm	a mm	L mm	d mm
80	98	7	16	1000	200
100	118	7.2	16	1000	220
150	170	7.8	18	1000	285
200	222	8.4	20	1000	340
250	274	9	20	1000	400
300	326	9.6	20.5	1000	455
350	378	10.2	20.5	1000	505
400	429	10.8	20.5	1000	565
500	532	12	22.5	1000	670
600	635	13.2	25	1000	780
700	738	14.4	27.5	1000	895
800	842	15.6	30	1000	1015

Note 1. Maximum length of a one-piece pipe manufactured in casting method is 1000 mm. however, this length can be increased to max. 6000 mm by means of welding at the request of customer.

Note 2. Parameter S indicates the point where a puddle is set at the order of customers and its tolerance is ± 5 .

Note 3. All weights have been calculated based on thickness class of K 12. In case you require other classes, please contact technical experts of Hanyco.

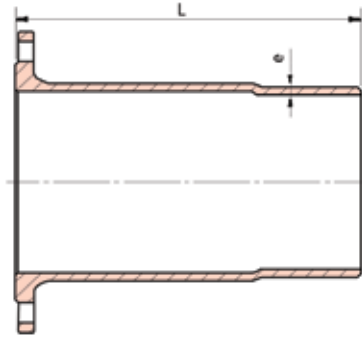

Flange spigot

F



DN	DE mm	e mm	L mm
80	98	7	350
100	118	7.2	360
150	170	7.8	380
200	222	8.4	400
250	274	9	420
300	326	9.6	440
350	378	10.2	460
400	429	10.8	480
500	532	12	520
600	635	13.2	560
700	738	14.4	600
800	842	15.6	600
900	945	16.8	600
1000	1048	18	600
1100	1152	19.2	600
1200	1255	20.4	600

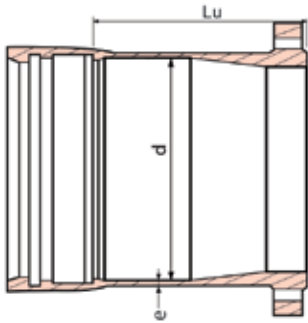

Flange socket tyton

EU



DN	d mm	e mm	Lu mm
80	109	7	160
100	130	7.2	160
150	183	7.8	165
200	235	8.4	170
250	288	9	175
300	340	9.6	180
350	393	10.2	185
400	445	10.8	190
500	550	12	200
600	655	13.2	210
700	760	14.4	220
800	865	15.6	230
900	970	16.8	210
1000	1075	18	220

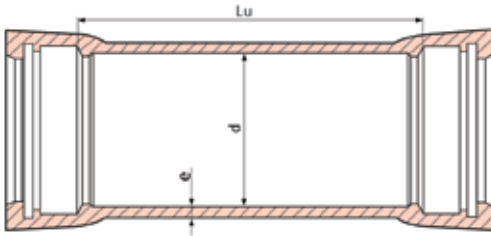

Collar tyton

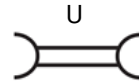

DN	d mm	e mm	Lu mm
80	109	7	160
100	130	7.2	160
150	183	7.8	165
200	235	8.4	170
250	288	9	175
300	340	9.6	180
350	393	10.2	185
400	445	10.8	190
500	550	12	200
600	655	13.2	210
700	760	14.4	220
800	865	15.6	230
900	970	16.8	240
1000	1075	18	250

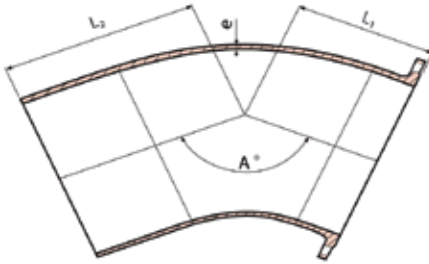

Flanged spigot bend †

A DN	11.25°			22.5°			45°			90°		
	L ₁ mm	L ₂ mm	e mm	L ₁ mm	L ₂ mm	e mm	L ₁ mm	L ₂ mm	e mm	L ₁ mm	L ₂ mm	e mm
80	113	210	7	130	220	7	130	289	7	165	280	7
100	115	210	7.2	140	220	7.2	140	323	7.2	180	300	7.2
150	113	215	7.8	160	235	7.8	160	359	7.8	220	350	7.8
200	132	220	8.4	180	245	8.4	180	396	8.4	260	400	8.4
250	165	230	9	106	255	9	360	586	9	350	450	9
300	175	235	9.6	210	265	9.6	400	480	9.6	400	500	9.6
350	191	240	10.2	131	275	10.2	298	543	10.2	450	550	10.2
400	104	245	10.8	149	290	10.8	324	581	10.8	500	600	10.8
500	121	275	12	176	330	12	375	679	12	600	720	12
600	138	285	13.2	203	350	13.2	426	755	13.2	700	820	13.2
700	154	345	14.4	234	425	14.4	478	908	14.4	800	830	14.4
800	171	360	15.6	256	445	15.6	529	981	15.6	750	876	15.6

† Designed based on factory standards

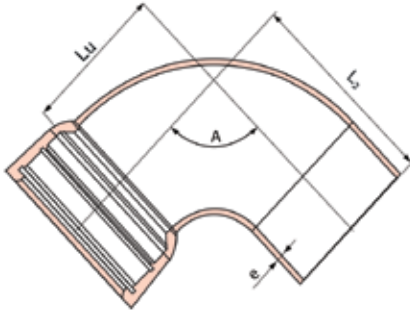

Socket-spigot bend †

MK



A \ DN	11.25°			22.5°			45°			(MQ) 90°		
	Lu mm	L mm	e mm	Lu mm	L mm	e mm	Lu mm	L mm	e mm	Lu mm	L mm	e mm
80	30	247	7	40	274	7	55	222	7	100	280	7
100	30	263	7.2	40	298	7.2	65	229	7.2	120	300	7.2
150	35	262	7.8	55	329	7.8	85	254	7.8	170	350	7.8
200	40	278	8.4	65	351	8.4	110	268	8.4	220	400	8.4
250	50	311	9	75	277	9	130	290	9	270	450	9
300	55	160	9.6	85	225	9.6	150	329	9.6	320	500	9.6
350	60	321	10.2	95	296	10.2	175	315	10.2	370	550	10.2
400	65	231	10.8	110	321	10.8	195	320	10.8	420	600	10.8
500	75	260	12	130	370	12	240	364	12	520	720	12
600	85	267	13.2	150	397	13.2	285	380	13.2	620	820	13.2
700	95	349	14.4	175	509	14.4	330	449	14.4	720	900	14.4
800	110	363	15.6	195	533	15.6	370	481	15.6	670	870	15.6

† Designed based on factory standards

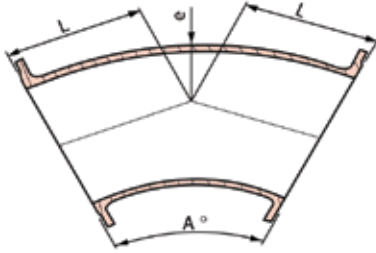

Double flanged bend



A \ DN	11.25°		22.5°		30°		45°		60°		(Q) 90°	
	L mm	e mm	L mm	e mm	L mm	e mm	L mm	e mm	L mm	e mm	L mm	e mm
80	113	7	130	7	130	7	130	7	130	7	165	7
100	115	7.2	140	7.2	140	7.2	140	7.2	137	7.2	180	7.2
150	113	7.8	160	7.8	160	7.8	160	7.8	158	7.8	220	7.8
200	132	8.4	180	8.4	180	8.4	180	8.4	178	8.4	260	8.4
250	165	9	106	9	210	9	360	9	245	9	350	9
300	175	9.6	210	9.6	255	9.6	400	9.6	294	9.6	400	9.6
350	191	10.2	131	10.2	165	10.2	298	10.2	304	10.2	450	10.2
400	104	10.8	149	10.8	183	10.8	324	10.8	335	10.8	500	10.8
500	121	12	176	12	220	12	375	12	393	12	600	12
600	138	13.2	203	13.2	309	13.2	426	13.2	453	13.2	700	13.2
700	154	14.4	234	14.4	346	14.4	478	14.4	513	14.4	800	14.4
800 †	171	15.6	256	15.6	383	15.6	529	15.6	575	15.6	750	15.6
900 †	185	16.8	285	16.8	-	-	581	16.8	-	-	1000	16.8
1000	201	18	327	18	-	-	535	18	-	-	1100	18
1100	213	19.2	333	19.2	-	-	578	19.2	-	-	1193	19.2
1200	231	20.4	331	20.4	-	-	631	20.4	-	-	1301	20.4

† 90 degree bend with 800 DN and 45 degree bend with 900 DN have been designed based on factory standards.

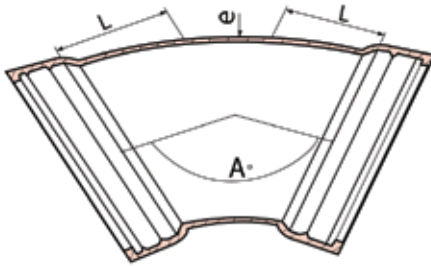

Double socket bend



A \ DN	11.25°		22.5°		30°		45°		60°		90°	
	Lu mm	e mm	Lu mm	e mm	Lu mm	e mm	Lu mm	e mm	Lu mm	e mm	Lu mm	e mm
80	30	7	40	7	45	7	55	7	106	7	100	7
100	30	7.2	40	7.2	50	7.2	65	7.2	122	7.2	120	7.2
150	35	7.8	55	7.8	65	7.8	85	7.8	145	7.8	170	7.8
200	40	8.4	65	8.4	80	8.4	110	8.4	162	8.4	220	8.4
250	50	9	75	9	95	9	130	9	221	9	270	9
300	55	9.6	85	9.6	143	9.6	150	9.6	196	9.6	320	9.6
350 †	60	10.2	95	10.2	125	10.2	175	10.2	269	10.2	370	10.2
400 †	65	10.8	110	10.8	140	10.8	195	10.8	301	10.8	420	10.8
500 †	75	12	130	12	170	12	240	12	350	12	520	12
600 †	85	13.2	150	13.2	200	13.2	285	13.2	404	13.2	620	13.2
700 †	95	14.4	175	14.4	230	14.4	330	14.4	470	14.4	720	14.4
800 †	110	15.6	195	15.6	260	15.6	370	15.6	531	15.6	670	15.6
900 †	120	16.8	220	16.8	-	-	415	16.8	-	-	935	16.8
1000 †	130	18	256	18	-	-	464	18	-	-	1029	18

† Designed based on factory standards

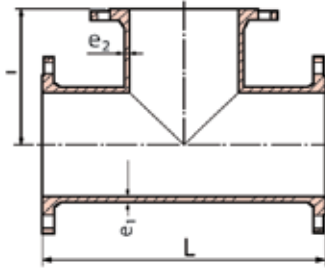

All flanged tee-Series A



DN	dn	L mm	l mm	K12		K14	
				e ₁ mm	e ₂ mm	e ₁ mm	e ₂ mm
80	80	330	165	6.9	6.9	8.1	8.1
100	80	360	175	7.2	6.9	8.4	8.1
100	100	360	180	7.2	7.2	8.4	8.4
150	80	440	205	7.8	6.9	9.1	8.1
150	100	440	210	7.8	7.2	9.1	8.4
150	150	440	220	7.8	7.8	9.1	9.1
200	80	520	235	8.4	6.9	9.8	8.1
200	100	520	240	8.4	7.2	9.8	8.4
200	150	520	250	8.4	7.8	9.8	9.1
200	200	520	260	8.4	8.4	9.8	9.8
250	80	500	265	9.0	6.9	10.5	8.1
250	100	700	275	9.0	7.2	10.5	8.4
250	150	700	300	9.0	7.8	10.5	9.1
250	200	700	325	9.0	8.4	10.5	9.8
250	250	700	350	9.0	9.0	10.5	10.5
300	80	550	290	9.6	6.9	11.2	8.1
300	100	800	300	9.6	7.2	11.2	8.4
300	150	800	325	9.6	7.8	11.2	9.1
300	200	800	350	9.6	8.4	11.2	9.8
300	250	800	375	9.6	9.0	11.2	10.5
300	300	800	400	9.6	9.6	11.2	11.2

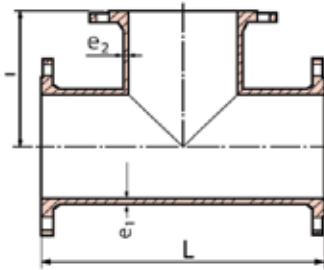

All flanged tee-Series A



DN	dn	L mm	l mm	K12		K14	
				e ₁ mm	e ₂ mm	e ₁ mm	e ₂ mm
350	80	600	325	10.2	6.9	11.9	8.1
350	100	850	325	10.2	7.2	11.9	8.4
350	150	850	325	10.2	7.8	11.9	9.1
350	200	850	325	10.2	8.4	11.9	9.8
350	250	850	325	10.2	9	11.9	10.5
350	300	850	425	10.2	9.6	11.9	11.2
350	350	850	425	10.2	10.2	11.9	11.9
400	80	650	350	10.8	6.9	12.6	8.1
400	100	900	350	10.8	7.2	12.6	8.4
400	150	900	350	10.8	7.8	12.6	9.1
400	200	900	350	10.8	8.4	12.6	9.8
400	250	900	350	10.8	9	12.6	10.5
400	300	900	450	10.8	9.6	12.6	11.2
400	350	900	450	10.8	10.2	12.6	11.9
400	400	900	450	10.8	10.8	12.6	12.6
500	80	1000	400	12	6.9	14	8.1
500	100	1000	400	12	7.2	14	8.4
500	150	1000	400	12	7.8	14	9.1
500	200	1000	400	12	8.4	14	9.8
500	250	1000	400	12	9	14	10.5
500	300	1000	500	12	9.6	14	11.2
500	350	1000	500	12	10.2	14	11.9
500	400	1000	500	12	10.8	14	12.6
500	500	1000	500	12	12	14	14
600	80	1100	450	13.2	6.9	15.4	8.1
600	100	1100	450	13.2	7.2	15.4	8.4
600	150	1100	450	13.2	7.8	15.4	9.1
600	200	1100	450	13.2	8.4	15.4	9.8
600	250	1100	500	13.2	9	15.4	10.5
600	300	1100	550	13.2	9.6	15.4	11.2

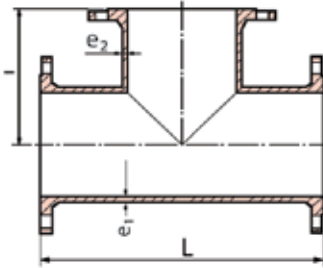

All flanged tee-Series A



DN	dn	L mm	l mm	K12		K14	
				e ₁ mm	e ₂ mm	e ₁ mm	e ₂ mm
600	350	1100	550	13.2	10.2	15.4	11.9
600	400	1100	550	13.2	10.8	15.4	12.6
600	500	1100	550	13.2	12	15.4	14
600	600	1100	550	13.2	13.2	15.4	15.4
700	80	650	500	14.4	6.9	16.8	8.1
700	100	650	505	14.4	7.2	16.8	8.4
700	150	650	515	14.4	7.8	16.8	9.1
700	200	650	525	14.4	8.4	16.8	9.8
700	250	650	530	14.4	9	16.8	10.5
700	300	760	540	14.4	9.6	16.8	11.2
700	350	820	550	14.4	10.2	16.8	11.9
700	400	870	555	14.4	10.8	16.8	12.6
700	500	1050	570	14.4	12	16.8	14
700 †	600	1000	585	14.4	13.2	16.8	15.4
700 †	700	1000	600	14.4	14.4	16.8	16.8
800	80	690	560	15.6	6.9	18.2	8.1
800	100	690	565	15.6	7.2	18.2	8.4
800	150	690	575	15.6	7.8	18.2	9.1
800	200	690	585	15.6	8.4	18.2	9.8
800	250	910	590	15.6	9	18.2	10.5
800	300	910	600	15.6	9.6	18.2	11.2
800	350	910	610	15.6	10.2	18.2	11.9
800	400	910	615	15.6	10.8	18.2	12.6
800 †	500	1000	630	15.6	12	18.2	14
800	600	1350	645	-	-	18.2	15.4
800	700	1350	660	-	-	18.2	16.8
800	800	1350	675	-	-	18.2	18.2

† Designed based on factory standards

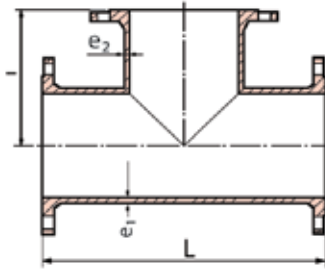

All flanged tee-Series A



DN	dn	L mm	I mm	K14	
				e ₁ mm	e ₂ mm
900	80	730	620	19.6	8.1
900	100	730	625	19.6	8.4
900	150	730	635	19.6	9.1
900	200	730	645	19.6	9.8
900	250	950	650	19.6	10.5
900	300	950	660	19.6	11.2
900	350	950	670	19.6	11.9
900	400	950	675	19.6	12.6
900	500	1500	690	19.6	14
900	600	1500	705	19.6	15.4
900	700	1500	720	19.6	16.8
900	800	1500	735	19.6	18.2
900	900	1500	750	19.6	19.6

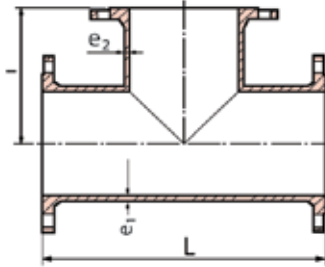

All flanged tee-Series A



DN	dn	L mm	l mm	K14	
				e ₁ mm	e ₂ mm
1000	80	770	685	21	8.1
1000	100	770	690	21	8.4
1000	150	770	70	21	9.1
1000	200	770	705	21	9.8
1000	250	990	710	21	10.5
1000	300	990	720	21	11.2
1000	350	990	725	21	11.9
1000	400	990	735	21	12.6
1000	500	1320	750	21	14
1000	600	1650	765	21	15.4
1000	700	1650	780	21	16.8
1000	800	1650	795	21	18.2
1000	900	1650	810	21	16.8
1000	1000	1650	825	21	21
1100	200	982	883	22.4	9.8
1100	250	982	875	22.4	10.5
1100	300	982	840	22.4	11.2
1100 †	400	982	835	22.4	12.6
1100 †	600	982	865	22.4	15.4
1100	700	1407	900	22.4	16.8
1100	800	1407	915	22.4	18.2
1100	900	1407	930	22.4	19.6
1100	1000	1407	920	22.4	21
1100	1100	1642	907	22.4	22.4

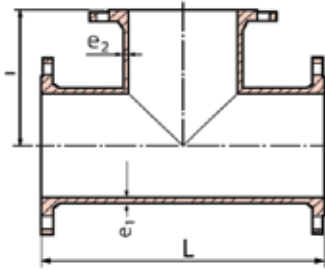

All flanged tee-Series A



DN	dn	L mm	l mm	K14	
				e ₁ mm	e ₂ mm
1200	100	712	815	23.8	8.4
1200	200	712	825	23.8	9.8
1200	250	712	835	23.8	10.5
1200	300	767	845	23.8	11.2
1200	350	767	850	23.8	11.9
1200	400	767	855	23.8	12.6
1200	500	1002	870	23.8	14
1200†	600	1002	885	23.8	15.4
1200	700	1117	900	23.8	16.8
1200 †	800	1232	915	23.8	18.2
1200	900	1462	930	23.8	19.6
1200 †	1000	1462	945	23.8	21
1200	1200	1697	975	23.8	23.8

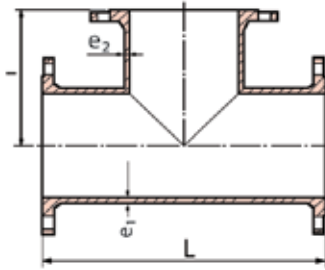

All Flanged Tee-Series B



DN	dn	L mm	l mm	K12		K14	
				e ₁ mm	e ₂ mm	e ₁ mm	e ₂ mm
80	80	330	165	6.9	6.9	8.1	8.1
100	80	330	170	7.2	6.9	8.4	8.1
100	100	360	180	7.2	7.2	8.4	8.4
150	80	360	200	7.8	6.9	9.1	8.1
150	100	380	205	7.8	7.2	9.1	8.4
150	150	440	220	7.8	7.8	9.1	9.1
200	80	380	225	8.4	6.9	9.8	8.1
200	100	400	230	8.4	7.2	9.8	8.4
200	150	460	245	8.4	7.8	9.8	9.1
200	200	520	260	8.4	8.4	9.8	9.8
250	80	405	265	9.0	6.9	10.5	8.1
250	100	425	270	9.0	7.2	10.5	8.4
250	150	485	280	9.0	7.8	10.5	9.1
250	200	540	290	9.0	8.4	10.5	9.8
250	250	600	300	9.0	9.0	10.5	10.5
300	80	425	295	9.6	6.9	11.2	8.1
300	100	450	300	9.6	7.2	11.2	8.4
300	150	505	310	9.6	7.8	11.2	9.1
300	200	565	320	9.6	8.4	11.2	9.8
300	250	620	330	9.6	9.0	11.2	10.5
300	300	680	340	9.6	9.6	11.2	11.2

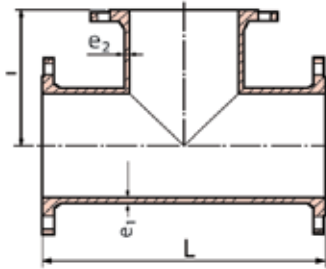

All Flanged Tee-Series B



DN	dn	L mm	l mm	K12		K14	
				e ₁ mm	e ₂ mm	e ₁ mm	e ₂ mm
350	80	445	325	10.2	6.9	11.9	8.1
350	100	470	330	10.2	7.2	11.9	8.4
350	150	530	340	10.2	7.8	11.9	9.1
350	200	585	350	10.2	8.4	11.9	9.8
350	250	645	360	10.2	9	11.9	10.5
350	350	760	380	10.2	10.2	11.9	11.9
400	80	470	355	10.8	6.9	12.6	8.1
400	100	490	360	10.8	7.2	12.6	8.4
400	150	550	370	10.8	7.8	12.6	9.1
400	200	610	380	10.8	8.4	12.6	9.8
400	250	665	390	10.8	9	12.6	10.5
400	300	725	400	10.8	9.6	12.6	11.2
400	400	840	420	10.8	10.8	12.6	12.6
500	100	535	420	12	7.2	14	8.4
500	150	592	430	12	7.8	14	9.1
500	200	650	440	12	8.4	14	9.8
500	300	767	460	12	9.6	14	11.2
500	400	885	480	12	10.8	14	12.6
500	500	1000	500	12	12	14	14
600	100	700	500	13.2	7.2	15.4	8.4
600	200	700	500	13.2	8.4	15.4	9.8
600	300	815	520	13.2	9.6	15.4	11.2
600	400	930	540	13.2	10.8	15.4	12.6
600	500	1047	560	13.2	12	15.4	14
600	600	1165	580	13.2	13.2	15.4	15.4

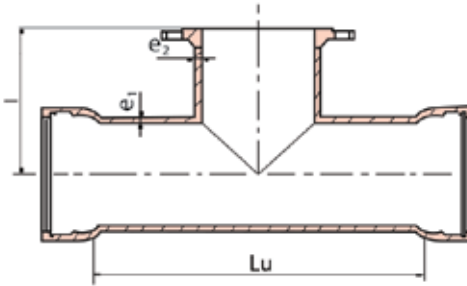

Double socket with
flanged tee

MMA

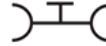

DN	dn	Lu mm	l mm	K12		K14	
				e ₁ mm	e ₂ mm	e ₁ mm	e ₂ mm
80	80	170	165	7.0	7.0	8.1	8.1
	100	170	175	7.2	7.0	8.4	8.1
100	100	190	180	7.2	7.2	8.4	8.4
	150	255	220	7.8	7.8	9.1	9.1
150	100	195	210	7.8	7.2	9.1	8.4
	80	170	205	7.8	7.0	9.1	8.1
200	200	315	260	8.4	8.4	9.8	9.8
	150	255	250	8.4	7.8	9.8	9.1
	100	200	240	8.4	7.2	9.8	8.4
	80	175	235	8.4	7.0	9.8	8.1
250	250	375	300	9.0	9.0	10.5	10.5
	200	315	290	9.0	8.4	10.5	9.8
	150	260	280	9.0	7.8	10.5	9.1
	100	200	270	9.0	7.2	10.5	8.4
	80	180	265	9.0	7.0	10.5	8.1
300	300	435	340	9.6	9.6	11.2	11.2
	250	380	330	9.6	9.0	11.2	10.5
	200	320	320	9.6	8.4	11.2	9.8
	150	260	310	9.6	7.8	11.2	9.1
	100	205	300	9.6	7.2	11.2	8.4
	80	180	295	9.6	7.0	11.2	8.1

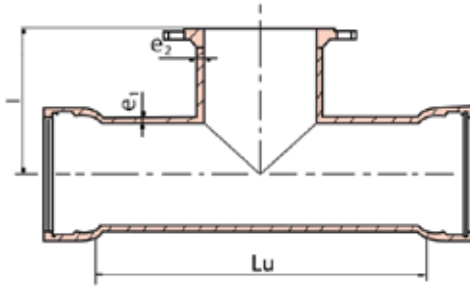

Double socket with
flanged tee

MMA

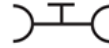

DN	dn	Lu mm	l mm	K12		K14	
				e ₁ mm	e ₂ mm	e ₁ mm	e ₂ mm
350	80	185	325	10.2	7.0	11.9	8.1
	100	205	330	10.2	7.2	11.9	8.4
	150	270	340	10.2	7.8	11.9	9.1
	200	325	350	10.2	8.4	11.9	9.8
	250	385	360	10.2	9.0	11.9	10.5
	300	420	370	10.2	9.6	11.9	11.2
	350	495	380	10.2	10.2	11.9	11.9
400	80	185	355	10.8	7.0	12.6	8.1
	100	210	360	10.8	7.2	12.6	8.4
	150	270	370	10.8	7.8	12.6	9.1
	200	325	380	10.8	8.4	12.6	9.8
	250	385	390	10.8	9.0	12.6	10.5
	300	440	400	10.8	9.6	12.6	11.2
	350	480	410	10.8	10.2	12.6	11.9
500 †	100	215	420	12.0	7.2	14.0	8.4
	200	330	440	12.0	8.4	14.0	9.8
	400	565	480	12.0	10.8	14.0	12.6
	500	680	500	12.0	12.0	14.0	14.0
600 †	200	340	500	13.2	8.4	15.4	9.8
	250	380	500	13.2	9.0	15.4	10.5
	400	570	540	13.2	10.8	15.4	12.6
	600	800	580	13.2	13.2	15.4	15.4

† Other sizes of the same family can be manufactured at the order of customers.

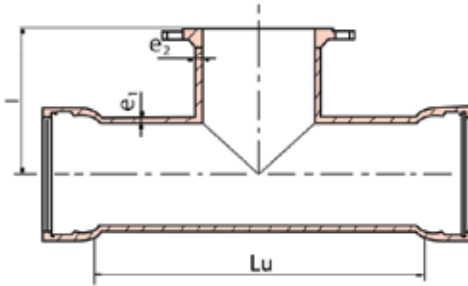

Double socket with
flanged tee



DN	dn	Lu mm	l mm	K12		K14	
				e ₁ mm	e ₂ mm	e ₁ mm	e ₂ mm
700 †	200	345	525	14.4	8.4	16.8	9.8
	400	575	555	14.4	10.8	16.8	12.6
800 †	200	350	585	15.6	8.4	18.2	9.8
	400	580	615	15.6	10.8	18.2	12.6
900	200	355	645	-	-	19.6	9.8
	400	590	675	-	-	19.6	12.6
	600	1170	705	-	-	19.6	15.4
	900	1170	750	-	-	19.6	19.6
1000	200	360	705	-	-	21	9.8
	400	595	735	-	-	21	12.6
	600	1290	765	-	-	21	15.4
	1000	1290	825	-	-	21	21

† Other sizes of the same family can be manufactured at the order of customers.

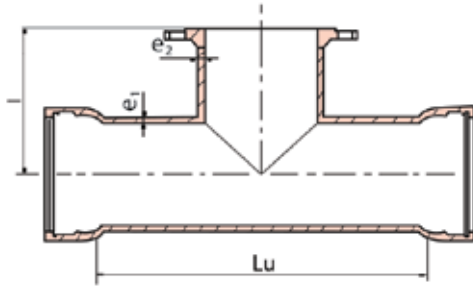

Double socket with
flanged tee

MMA

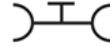

DN	dn	Lu mm	l mm	K14	
				e ₁ mm	e ₂ mm
900	200	355	645	19.6	9.8
	400	590	675	19.6	12.6
	600	1170	705	19.6	15.4
	900	1170	750	19.6	19.6
1000	200	360	705	21	9.8
	400	595	735	21	12.6
	600	1290	765	21	15.4
	1000	1290	825	21	21

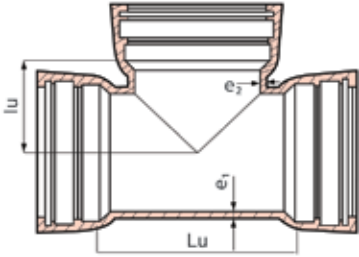

All socket tee

MMB

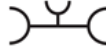

DN	dn	Lu mm	lu mm	K12		K14	
				e ₁ mm	e ₂ mm	e ₁ mm	e ₂ mm
80	80	170	85	6.9	6.9	8.1	8.1
100	100	190	95	7.2	7.2	8.4	8.4
100	80	170	95	7.2	6.9	8.4	8.1
150	150	255	125	7.8	7.8	9.1	9.1
150	100	195	120	7.8	7.2	9.1	8.4
150	80	170	120	7.8	6.9	9.1	8.1
200	200	315	155	8.4	8.4	9.8	9.8
200	150	255	150	8.4	7.8	9.8	9.1
200	100	200	145	8.4	7.2	9.8	8.4
200	80	175	145	8.4	6.9	9.8	8.1
250	250	375	190	9	9	10.5	10.5
250	200	315	180	9	8.4	10.5	9.8
250	150	260	175	9	7.8	10.5	9.1
250	100	200	170	9	7.2	10.5	8.4
250	80	180	170	9	6.9	10.5	8.1

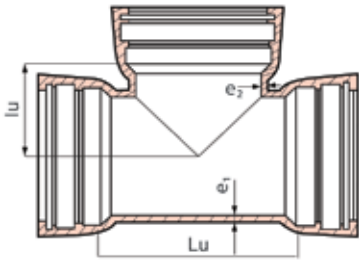

All socket tee

MMB

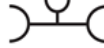

DN	dn	Lu mm	lu mm	K12		K14	
				e ₁ mm	e ₂ mm	e ₁ mm	e ₂ mm
300	300	435	220	9.6	9.6	11.2	11.2
300	250	375	210	9.6	9	11.2	10.5
300	200	320	205	9.6	8.4	11.2	9.8
300	150	260	200	9.6	7.8	11.2	9.1
300	100	205	195	9.6	7.2	11.2	8.4
350 †	350	500	255	10.2	10.2	11.9	11.9
400 †	400	560	280	10.8	10.8	12.6	12.6
500 †	500	680	340	12	12	14	14
600 †	600	800	400	13.2	13.2	15.4	15.4

† Designed based on factory standards

All fittings of various sizes in each category can be produced at the request and order of customers.

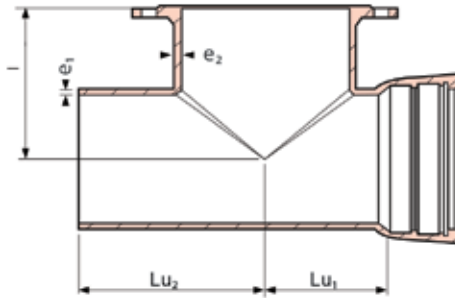

Socket - spigot with
flanged tee



DN	dn	e ₁ mm	Lu ₁ mm	Lu ₂ mm	e ₂ mm	l mm
80	80	8.4	85	277	8.1	165
100	100	8.7	95	280	8.4	180
100	80	8.7	85	272	8.1	175
150	150	9.4	128	328	9.1	220
150	100	9.4	97.5	272.5	8.4	210
150	80	9.4	85	257	8.1	205
200	200	10.1	158	368	9.8	260
200	150	10.1	127.5	312.5	9.1	250
200	100	10.1	100	260	8.4	240
200	80	10.1	87.5	244.5	8.1	235
250	250	10.8	188	408	10.5	300
250	200	10.8	157.5	352.5	9.8	290
250	150	10.8	130	300	9.1	280
250	100	10.8	100	265	8.4	270
250	80	10.8	90	257	8.1	265
300	300	11.6	218	448	11.2	340
300	250	11.6	190	395	10.5	330
300	200	11.6	160	340	9.8	320
300	150	11.6	130	285	9.1	310
300	100	11.6	102.5	237.5	8.4	300
300	80	11.6	90	242	8.1	295
350	350	12.3	248	488	11.9	380

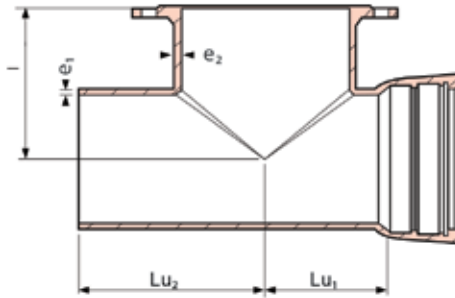

Socket - spigot with
flanged tee †

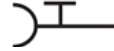

DN	dn	e ₁ mm	Lu ₁ mm	Lu ₂ mm	e ₂ mm	l mm
350	250	12.3	192.5	382.5	10.5	360
350	200	12.3	162.5	327.5	9.8	350
350	150	12.3	135	305	9.1	340
350	100	12.3	102.5	247.5	8.4	330
350	80	12.3	92.5	229.5	8.1	325
400	80	13.0	92.5	214.5	8.1	355
400	100	13.0	105	235	8.4	360
400	150	13.0	135	290	9.1	370
400	200	13.0	162.5	317.5	9.8	380
400	250	13.0	192.5	372.5	10.5	390
400	300	13.0	220	420	11.2	400
500	100	14.4	107.5	227.5	8.4	420
500	200	14.4	165	335	9.8	440
500	400	14.4	282.5	527.5	12.6	480
600	200	15.9	170	310	9.8	500
600	400	15.9	285	500	12.6	540
700	200	17.3	172.5	309.5	9.8	525
700	400	17.3	187.5	449.5	12.6	555
800	200	18.8	175	292	9.8	585
800	400	18.8	290	522	12.6	615

† Designed based on factory standards

This fitting can be manufactured at 25 Bar work pressure at the request of customers.

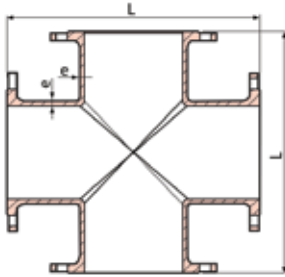

All flanged cross



DN	dn	e mm	L mm
80	80	8.1	330
100	100	8.4	360
150	150	9.1	440
200	200	9.8	520
250	250	10.5	700
300	300	11.2	800
350	350	11.9	850
400	400	12.6	900
500	500	14	1000
600	600	15.4	1100
700	700	16.8	1200
800	800	18.2	1350

This type of cross can be produced with various sized flanges at the request of customers.

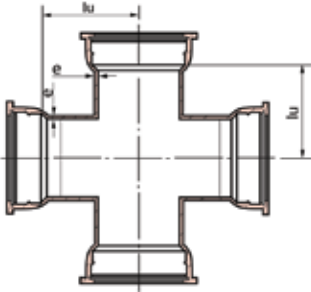

All socket cross †



DN	dn	e (mm)	Lu (mm)
80	80	8.1	85
100	100	8.4	95
150	150	9.1	125
200	200	9.8	155
250	250	10.5	190
300	300	11.2	220
350	350	11.9	255
400	400	12.6	280
500	500	14	340

† Designed based on factory standards

This type of cross can be produced with various sized sockets at the request of customers.

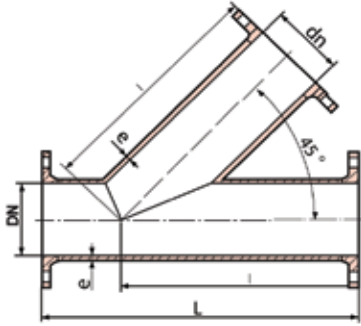

All flanged tee
with **45°** branch †

FFC



DN	dn	e mm	L mm	l mm
80	80	7	360	280
100	100	7.2	400	310
150	150	7.8	500	390
200	200	8.4	600	470
250	250	9	700	550
300	300	9.6	930	715
350	350	10.2	900	700
400	400	10.8	1000	800

† Designed based on factory standards

All fittings of various sizes in each category can be produced at the request and order of customers.

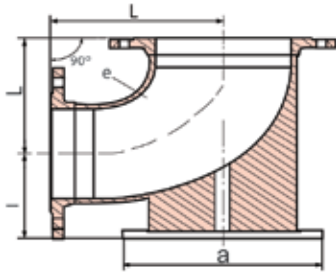

Double flanged duckfoot bend



A DN	L mm	e mm	l mm	a mm
80	165	7	110	180
100	180	7.2	125	200
150	220	7.8	160	250
200	260	8.4	190	300
250	350	9	225	350
300	400	9.6	255	400
350	450	10.2	290	450
400	500	10.8	320	500
500	600	12	385	600
600	700	13.2	450	700

Note: This fitting can be manufactured at 25 Bar work pressure at the request of customers.

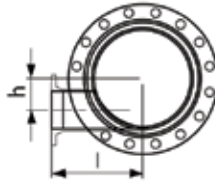
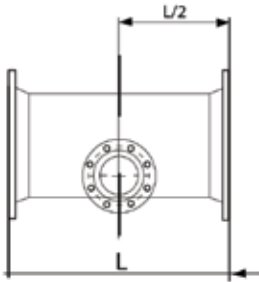

All flanged inverted tee †



DN	dn	e ₁ mm	e ₂ mm	L mm	l m	h mm
200	100	9.8	8.4	520	250	52
250	150	10.5	9.1	700	265	51
300	100	11.2	8.4	800	305	104
	150	11.2	9.1	800	305	78
	250	11.2	10.5	800	320	26
350	250	11.9	10.5	850	340	52
400	100	12.6	8.4	900	365	155.5
	150	12.6	9.1	900	365	129.5
	300	12.6	11.2	900	380	51
500	300	14	11.2	1000	450	103
600	150	15.4	9.1	1100	450	232.5
	200	15.4	9.8	1100	450	206.5
	300	15.4	10.5	1100	580	154.5
700	350	16.8	11.9	815	525	180
800	150	18.2	9.1	690	500	336
900	150	-	-	730	580	381.2
	200	-	-	730	580	355.3
	400	-	-	950	680	253.5
1000	300	11.2	9.1	990	650	354
1200	200	11.2	10.5	592	750	507
	250	11.9	10.5	900	750	482
	300	12.6	8.4	767	750	456
	1000	12.6	9.1	1500	850	101

† Designed based on factory standards

This type of cross can be produced with various sized sockets at the request of customers.

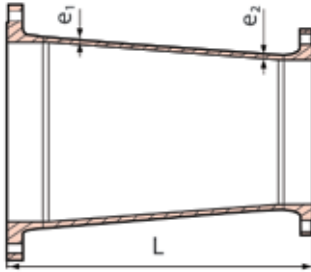

Double flanged taper

FFR



DN	dn	e ₁ mm	e ₂ mm	L mm
100	80	7.2	7	200
150	80	7.8	7	380
150	100	7.8	7.2	200
200	80	8.4	7	650
200	100	8.4	7.2	580
200	150	8.4	7.8	300
250	80	9	7	300
250	100	9	7.2	300
250	150	9	7.8	300
250	200	9	8.4	300
300	80	9.6	7	300
300	100	9.6	7.2	300
300	150	9.6	7.8	300
300	200	9.6	8.4	300
300	250	9.6	9	300
350	150	10.2	7.8	600
350	200	10.2	8.4	300
350	250	10.2	9	300
350	300	10.2	9.6	300
400	150	10.8	7.8	750
400	200	10.8	8.4	300
400	250	10.8	9	300
400	300	10.8	9.6	300
400	350	10.8	10.2	300

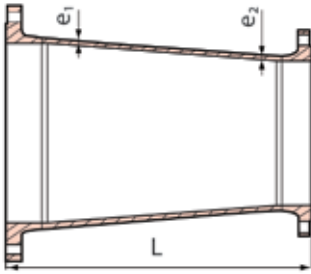

Double flanged taper

FFR



DN	dn	e ₁ mm	e ₂ mm	L mm
500	200	12	8.4	800
500	250	12	9	700
500	300	12	9.6	600
500	350	12	10.2	600
500	400	12	10.8	600
600	250	13.2	9	900
600	300	13.2	9.6	600
600	350	13.2	10.2	600
600	400	13.2	10.8	600
600	500	13.2	12	600
700	300	14.4	9.6	900
700	350	14.4	10.2	700
700	400	14.4	10.8	600
700	500	14.4	12	600
700	600	14.4	13.2	600
800	400	15.6	10.8	600
800	500	15.6	12	600
800	600	15.6	13.2	600
800	700	15.6	14.4	600
900	200	16.8	8.4	1600
900	300	16.8	9.6	1400
900	400	16.8	10.8	1200
900	500	16.8	12	1000
900	600	16.8	13.2	800
900	700	16.8	14.4	600
900	800	16.8	15.6	600

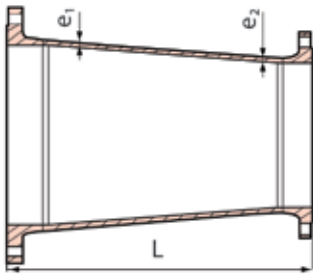

Double flanged taper

FFR



DN	dn	e ₁ mm	e ₂ mm	L mm
1000	400	18	10.8	1400
1000	600	18	13.2	1000
1000	700	18	14.4	800
1000	800	18	15.6	950
1000	900	19	16.8	600
1100	700	19.2	14.4	1000
1100	800	19.2	15.6	800
1100	900	19.2	16.8	700
1100	1000	19.2	18	600
1200	600	20.4	13.2	1530
1200	800	20.4	15.6	1160
1200	1000	20.4	18	790

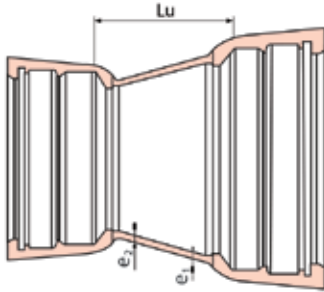

Double socket tyton taper

MMR



DN	dn	e ₁ mm	e ₂ mm	Lu mm
100	80	7.2	7	160
150	80	7.8	7	345
150	100	7.8	7.2	170
200	100	8.4	7.2	550
200	150	8.4	7.8	270
250	150	9	7.8	250
250	200	9	8.4	150
300	100	9.6	7.2	430
300	150	9.6	7.8	350
300	200	9.6	8.4	250
300	250	9.6	9	150
350	150	10.2	7.8	460
350	200	10.2	8.4	360
350	250	10.2	9	260
350	300	10.2	9.6	160
400	150	10.8	7.8	560
400	200	10.8	8.4	460
400	250	10.8	9	360
400	300	10.8	9.6	260
400	350	10.8	10.2	160

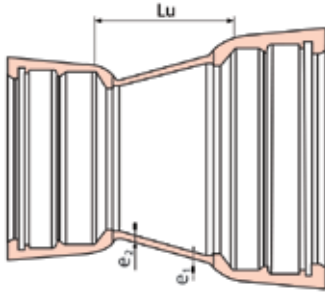

Double socket tyton taper

MMR



DN	dn	e ₁ mm	e ₂ mm	Lu mm
500	100	12	7.2	860
500	150	12	7.8	760
500	200	12	8.4	660
500	250	12	9	560
500	300	12	9.6	460
500	350	12	10.2	360
500	400	12	10.8	260
600	100	13.2	7.2	1060
600	150	13.2	7.8	960
600	200	13.2	8.4	860
600	250	13.2	9	760
600	300	13.2	9.6	660
600	350	13.2	10.2	560
600	400	13.2	10.8	460
600	500	13.2	12	260
700	200	14.4	8.4	1080
700	250	14.4	9	980
700	300	14.4	9.6	880
700	350	14.4	10.2	780
700	500	14.4	12	480
700	600	14.4	13.2	280
800	400	15.6	10.8	880
800	500	15.6	12	680
800	600	15.6	13.2	480
800	700	15.6	14.4	280
900	700	16.8	14.4	480
900	800	16.8	15.6	280
1000	800	18	15.6	480
1000	900	18	16.8	280

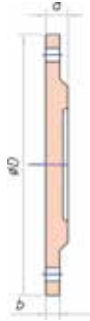

Blank Flange

X



DN	PN 10			PN 16			PN 25		
	D	a	b	D	a	b	D	a	d
80	200	19	16	200	19	16	200	19	16
100	220	19	16	220	19	16	235	19	16
150	285	19	16	285	19	16	300	20	17
200	340	20	17	340	20	17	360	22	19
250	400	22	19	400	22	19	425	24.5	21.5
300	455	24.5	20.5	455	24.5	20.5	485	27.5	23.5
350	505	24.5	20.5	520	26.5	22.5	555	30	26
400	565	24.5	20.5	580	28	24	620	32	28
500	670	26	5	715	31.5	27.5	730	36.5	32.5
600	780	30	25	840	36	31	845	42	37
700	895	32.5	27.5	910	39.5	34.5	960	46.5	41.5
800	1015	35	30	1025	43	38	1085	51	46
900	1115	37.5	32.5	1125	46.5	41.5	1185	55.5	50.5
1000	1230	40	35	1255	50	45	1320	60	55
1100	1340	42.5	37.5	1355	53.5	48.5	1420	64.5	59.5
1200	1455	45	40	1485	57	52	1530	69	64

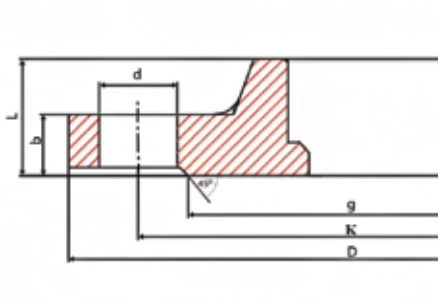

Socket weld flange
(PN 10 bar)

DN	L	D	g	K	b	d	screw	Hole No.
80	43	200	132	160	16	19	M16	8
100	45	220	156	180	16	19	M16	8
150	50	285	211	240	16	23	M20	8
200	55	340	266	295	17	23	M20	8
250	60	400	319	350	19	23	M20	12
300	65	455	368	400	20.5	23	M20	12
350	70	505	429	460	20.5	23	M20	16
400	75	565	478	515	20.5	28	M24	16
500	85	670	582	620	22.5	28	M24	20
600	95	780	682	725	25	31	M27	20
700	105	895	794	840	27.5	31	M27	24
800	114	1015	901	950	30	34	M30	24

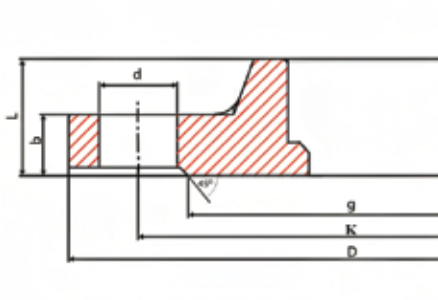

Socket weld flange
(PN16 bar)

cccDN	L	D	g	K	b	f	d	screw	Hole No.
80	43	200	132	160	16	3	19	M16	8
100	45	220	156	180	16	3	19	M16	8
150	50	285	211	240	16	3	23	M20	8
200	55	340	266	295	17	3	23	M20	12
250	60	400	319	355	19	3	28	M24	12
300	65	455	370	410	20.5	4	28	M24	12
350	70	520	429	470	22.5	4	28	M24	16
400	75	580	480	525	24	4	31	M27	16
500	85	715	609	650	27.5	4	34	M30	20
600	95	840	720	770	31	5	37	M33	20
700	105	910	794	840	34.5	5	37	M33	24
800	114	1025	901	950	38	5	40	M36	24
900	125	1125	1001	1050	41.5	5	41	M36	28

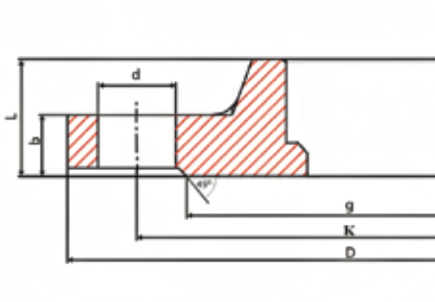

Socket weld flange
(PN 25 bar)

DN	L	D	g	K	b	d	c	screw	Hole No.
80	43	200	132	160	16	3	19	M16	8
100	45	235	156	190	16	3	23	M20	8
150	50	300	211	250	17	3	28	M24	8
200	55	360	274	310	19	3	28	M24	12
250	60	425	330	370	21.5	3	31	M27	12
300	65	485	389	430	23.5	4	31	M27	16
350	70	555	448	490	26	4	34	M30	16
400	75	620	495	550	28	4	37	M33	16
500	85	730	601	660	32.5	4	37	M33	20
600	95	845	710	770	37	5	41	M36	20
700	105	960	810	875	41.5	5	44	M39	24
800	114	1085	928	990	46	5	49	M45	24

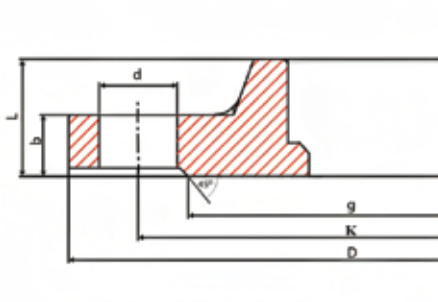

Socket weld flange
(PN 40 bar)

DN	L	D	g	K	b	F	d	screw	Hole No.
80	43	200	132	160	16	3	19	M16	8
100	45	235	156	190	24	3	23	M20	8
150	50	300	211	250	28	3	28	M24	8
200	55	375	284	320	34	3	31	M27	12
250	60	450	345	385	38	3	34	M30	12
300	65	515	409	450	42	4	34	M30	16
350	70	580	465	510	46	4	37	M33	16
400	75	660	533	585	50	4	40	M36	16
500	85	755	615	670	57	4	43	M39	20
600	95	890	735	795	72	5	49	M45	20

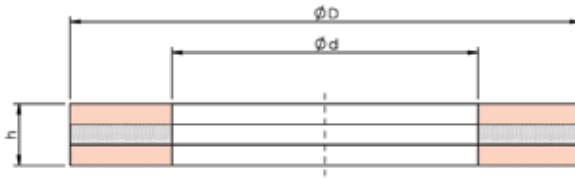

Flanged Gasket

DN	d	D PN 10	D PN 16	D PN 25	D PN 40
80	89	142	142	142	142
100	115	163	162	168	168
150	169	218	218	224	224
200	220	273	273	284	290
250	273	328	329	340	352
300	324	378	384	400	417
350	356	438	444	457	474
400	407	489	495	514	546
450	458	539	555	564	571
500	508	594	617	624	628
600	610	695	734	731	747
700	712	810	804	833	-
800	813	917	911	942	-
900	915	1017	6011	1042	-
1000	1016	1124	1128	1154	-
1100	1120	1231	1228	1254	-
1200	1220	1341	1342	1364	-

DN	80-600	700-1200
Min h(PN<25)	3	5
Min h(PN40)	4	-

The material for production of flange washer can be NR or EPDM at the request of customers.
Hardness of washers must be 60 to 70 Shore A.

Hexagon head screwst and nuts for flanges

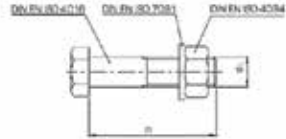
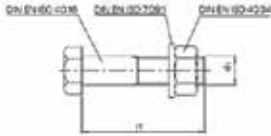

DN	PN 10			PN 16			PN 25			PN 40		
	d ₁	l ₁	qty per joint	d ₁	l ₁	qty per joint	d ₁	l ₁	qty per joint	d ₁	l ₁	qty per joint
80	M16	65	8	M16	65	8	M16	65	8	M16	65	8
100	M16	65	8	M16	65	8	M20	80	8	M20	80	8
125	M16	65	8	M16	65	8	M24	100	8	M24	100	8
150	M20	80	8	M20	80	8	M24	100	8	M24	100	8
200	M20	80	8	M20	80	12	M24	100	12	M27	110	12
250	M20	80	12	M24	100	12	M27	110	12	M30	120	12
300	M20	90	12	M24	100	12	M27	100	16	M30	120	16
350	M20	90	16	M24	100	16	M30	120	16	M33	130	16
400	M24	100	16	M27	110	16	M33	130	16	M36	140	16
450	M24	100	20	M27	110	20	M33	130	20	M36	140	20
500	M24	100	20	M30	120	20	M33	130	20	M39	150	20
600	M27	110	20	M33	130	20	M36	140	20	M45	180	20
700	M27	120	24	M33	130	24	M39	150	24	-	-	-
800	M30	120	24	M36	140	24	M45	180	24	-	-	-
900	M30	130	28	M36	160	28	M45	180	28	-	-	-
1000	M33	140	28	M39	160	28	M52	200	28	-	-	-
1200	M36	160	32	M45	180	32	M52	220	32	-	-	-

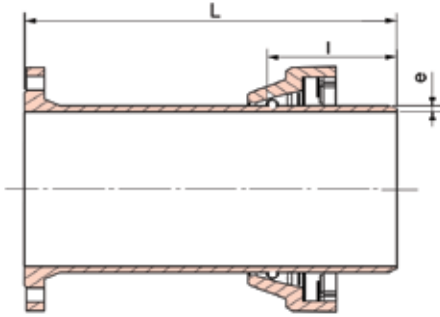

Flanged spigot R.J

DN	e mm	l mm	Lu mm
80	7	97	350
100	7.2	101	360
150	7.8	108	380
200	8.4	114	400
250	9	119	420
300	9.6	123	440
350	10.2	124	460
400	10.8	124	480
500	12	136	520
600	13.2	136	560
700	14.4	166	600
800	15.6	176	600

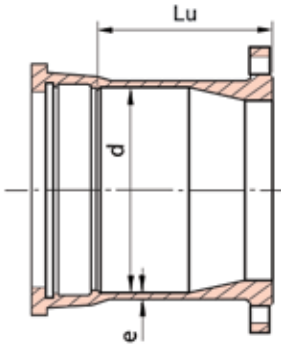

Flanged socket R.J

DN	d mm	e mm	Lu mm
80	109	7	130
100	130	7.2	130
150	183	7.8	135
200	235	8.4	140
250	288	9	145
300	340	9.6	150
350	393	10.2	155
400	445	10.8	160
500	550	12	170
600	655	13.2	180
700	760	14.4	190
800	865	15.6	200

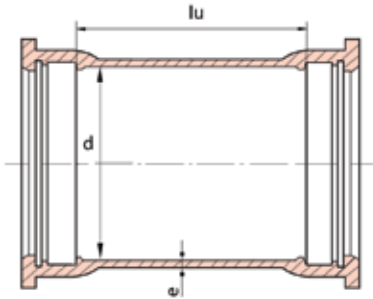

Collar tyton R.J

DN	d mm	e mm	Lu mm
80	109	7	160
100	130	7.2	160
150	183	7.8	165
200	235	8.4	170
250	288	9	175
300	340	9.6	180
350	393	10.2	185
400	445	10.8	190
500	550	12	200
600	655	13.2	210
700	760	14.4	220
800	865	15.6	230

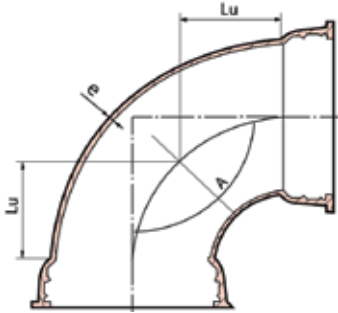

Double socket bend - R.J

A DN	11.25°		22.5°		30°		45°		60°		90°	
	Lu mm	e mm	Lu mm	e mm	Lu mm	e mm	Lu mm	e mm	Lu mm	e mm	Lu mm	e mm
80	30	7	40	7	45	7	55	7	106	7	100	7
100	30	7.2	40	7.2	50	7.2	65	7.2	122	7.2	120	7.2
150	35	7.8	55	7.8	65	7.8	85	7.8	145	7.8	170	7.8
200	40	8.4	65	8.4	80	8.4	110	8.4	162	8.4	220	8.4
250	50	9	75	9	95	9	130	9	221	9	270	9
300	55	9.6	85	9.6	143	9.6	150	9.6	196	9.6	320	9.6
350	60	10.2	95	10.2	125	10.2	175	10.2	269	10.2	370	10.2
400	65	10.8	110	10.8	140	10.8	195	10.8	301	10.8	420	10.8
500	75	12	130	12	170	12	240	12	350	12	520	12
600	85	13.2	150	13.2	200	13.2	285	13.2	404	13.2	620	13.2
700	95	14.4	175	14.4	230	14.4	330	14.4	470	14.4	720	14.4
800	110	15.6	195	15.6	260	15.6	370	15.6	531	15.6	670	15.6

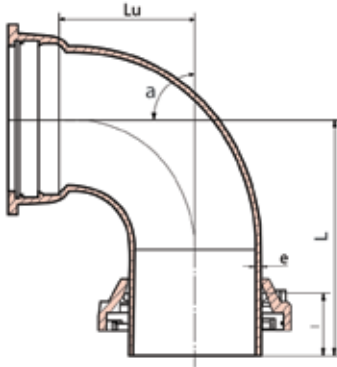

Socket-spigot bend R.J

A DN	11.25°				22.5°				45°				90°			
	Lu mm	L mm	l mm	e mm	Lu mm	L mm	l mm	e mm	Lu mm	L mm	l mm	e mm	Lu mm	L mm	l mm	e mm
80	30	212	97	7	40	222	97	7	55	222	97	7	100	282	97	7
100	30	219	101	7.2	40	229	101	7.2	65	229	101	7.2	120	309	101	7.2
150	35	234	108	7.8	55	254	108	7.8	85	254	108	7.8	170	369	108	7.8
200	40	243	114	8.4	65	268	114	8.4	110	268	114	8.4	220	423	114	8.4
250	50	265	119	9	75	290	119	9	130	290	119	9	270	485	119	9
300	55	299	123	9.6	85	329	123	9.6	150	329	123	9.6	320	537	123	9.6
350	60	280	124	10	95	315	124	10.2	175	315	124	10.2	370	590	124	10.2
400	65	275	124	11	110	320	124	10.8	195	320	124	10.8	420	630	124	10.8
500	75	309	136	12	130	364	136	12	240	364	136	12	520	754	136	12
600	85	315	136	13	150	380	136	13.2	285	380	136	13.2	620	850	136	13.2
700	95	369	166	14	175	449	166	14.4	330	449	166	14.4	720	994	166	14.4
800	110	396	176	16	195	481	176	15.6	370	481	176	15.6	670	870	176	15.6

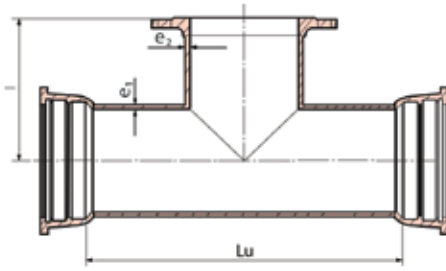

Double socket with flanged
tee R.J

DN	dn	Lu mm	l mm	K12		K14	
				e ₁ mm	e ₂ mm	e ₁ mm	e ₂ mm
80	80	170	165	7.0	7.0	8.1	8.1
100	80	170	175	7.2	7.0	8.4	8.1
	100	190	180	7.2	7.2	8.4	8.4
150	150	255	220	7.8	7.8	9.1	9.1
	100	195	210	7.8	7.2	9.1	8.4
	80	170	205	7.8	7.0	9.1	8.1
200	200	315	260	8.4	8.4	9.8	9.8
	150	255	250	8.4	7.8	9.8	9.1
	100	200	240	8.4	7.2	9.8	8.4
	80	175	235	8.4	7.0	9.8	8.1
250	250	375	300	9.0	9.0	10.5	10.5
	200	315	290	9.0	8.4	10.5	9.8
	150	260	280	9.0	7.8	10.5	9.1
	100	200	270	9.0	7.2	10.5	8.4
	80	180	265	9.0	7.0	10.5	8.1
300	300	435	340	9.6	9.6	11.2	11.2
	250	380	330	9.6	9.0	11.2	10.5
	200	320	320	9.6	8.4	11.2	9.8
	150	260	310	9.6	7.8	11.2	9.1
	100	205	300	9.6	7.2	11.2	8.4
	80	180	295	9.6	7.0	11.2	8.1

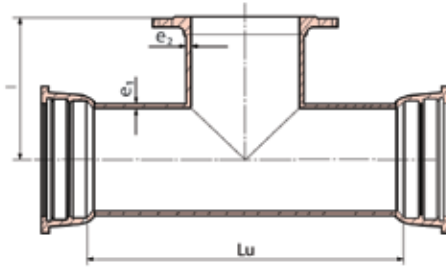

Double socket with flanged
tee R.J

DN	dn	Lu mm	l mm	K12		K14	
				e ₁ mm	e ₂ mm	e ₁ mm	e ₂ mm
350	80	185	325	10.2	7.0	11.9	8.1
	100	205	330	10.2	7.2	11.9	8.4
	150	270	340	10.2	7.8	11.9	9.1
	200	325	350	10.2	8.4	11.9	9.8
	250	385	360	10.2	9.0	11.9	10.5
	300	420	370	10.2	9.6	11.9	11.2
	350	495	380	10.2	10.2	11.9	11.9
400	80	185	355	10.8	7.0	12.6	8.1
	100	210	360	10.8	7.2	12.6	8.4
	150	270	370	10.8	7.8	12.6	9.1
	200	325	380	10.8	8.4	12.6	9.8
	250	385	390	10.8	9.0	12.6	10.5
	300	440	400	10.8	9.6	12.6	11.2
	350	480	410	10.8	10.2	12.6	11.9
500 †	100	215	420	12.0	7.2	14.0	8.4
	200	330	440	12.0	8.4	14.0	9.8
	400	565	480	12.0	10.8	14.0	12.6
	500	680	500	12.0	12.0	14.0	14.0
600 †	200	340	500	13.2	8.4	15.4	9.8
	250	380	500	13.2	9.0	15.4	10.5
	400	570	540	13.2	10.8	15.4	12.6
700 †	600	800	580	13.2	13.2	15.4	15.4
	200	345	525	14.4	8.4	16.8	9.8
800 †	400	575	555	14.4	10.8	16.8	12.6
	200	350	585	15.6	8.4	18.2	9.8
800 †	400	580	615	15.6	10.8	18.2	12.6

† Other sizes of the same family can be manufactured at the order of customers.

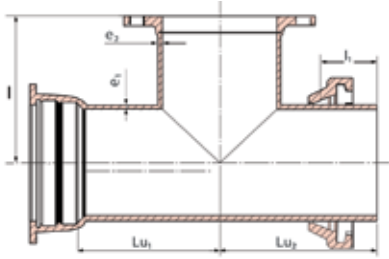

Socket-spigot with flanged
tee R.J

DN	dn	e ₁ mm	Lu ₁ mm	Lu ₂ mm	e ₂ mm	l ₁ mm	l mm
80	80	8.4	85	277	8.1	97	165
100	80	8.7	85	287	8.1	101	175
	100	8.7	95	297	8.4	101	180
150	150	9.4	127.5	345	9.1	108	220
	100	9.4	97.5	312.5	8.4	108	210
	80	9.4	85	302.5	8.1	108	205
200	200	10.1	157.5	378.5	9.8	114	260
	150	10.1	127.5	351	9.1	114	250
	100	10.1	100	318.5	8.4	114	240
	80	10.1	87.5	308.5	8.1	114	235
250	250	10.8	187.5	416.5	10.5	119	300
	200	10.8	157.5	386.5	9.8	119	290
	150	10.8	130	359	9.1	119	280
	100	10.8	100	326.5	8.4	119	270
	80	10.8	90	316.5	8.1	119	265

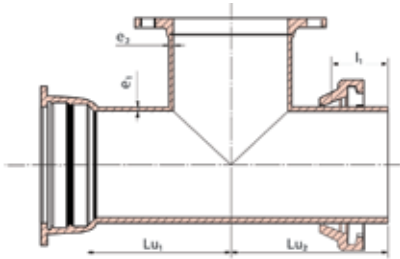

Socket-spigot with flanged
tee R.J

DN	dn	e ₁ mm	Lu ₁ mm	Lu ₂ mm	e ₂ mm	l ₁ mm	l mm
300	300	11.6	217.5	451.5	11.2	123	340
	250	11.6	190	424	10.5	123	330
	200	11.6	160	394	9.8	123	320
	150	11.6	130	366.5	9.1	123	310
	100	11.6	102.5	334	8.4	123	300
	80	11.6	90	324	8.1	123	295
350	80	12.3	92.5	325	8.1	124	325
	100	12.3	102.5	335	8.4	124	330
	150	12.3	135	367.5	9.1	124	340
	200	12.3	162.5	395	9.8	124	350
	250	12.3	192.5	425	10.5	124	360
	350	12.3	247.5	485	11.9	124	380
400	80	13.0	92.5	320	8.1	124	355
	100	13.0	105	330	8.4	124	360
	150	13.0	135	362.5	9.1	124	370
	200	13.0	162.5	390	9.8	124	380
	250	13.0	192.5	420	10.5	124	390
	300	13.0	220	447.5	11.2	124	400
	400	13.0	280	510	12.6	124	420
500	100	14.4	107.5	354	8.4	136	420
	200	14.4	165	414	9.8	136	440
	400	14.4	282.5	534	12.6	136	480

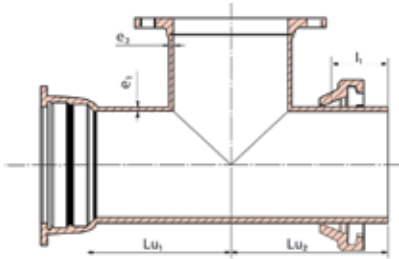

Socket-spigot with flanged
tee R.J

DN	dn	e_1 mm	Lu_1 mm	Lu_2 mm	e_2 mm	l_1 mm	l mm
600	200	15.9	170	415	9.8	136	500
	400	15.9	285	535	12.6	136	540
700	200	17.3	172.5	464	9.8	166	525
	400	17.3	187.5	584	12.6	166	555
800	200	18.8	175	486	9.8	176	585
	400	18.8	290	606	12.6	176	615

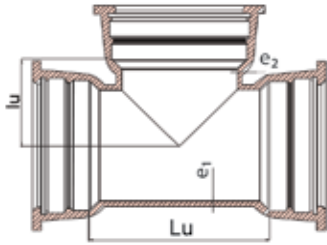

All socket tee - R.J

DN	dn	Lu mm	lu mm	K12		K14	
				e ₁ mm	e ₂ mm	e ₁ mm	e ₂ mm
80	80	170	85	6.9	6.9	8.1	8.1
100	100	190	95	7.2	7.2	8.4	8.4
100	80	170	95	7.2	6.9	8.4	8.1
150	150	255	125	7.8	7.8	9.1	9.1
150	100	195	120	7.8	7.2	9.1	8.4
150	80	170	120	7.8	6.9	9.1	8.1
200	200	315	155	8.4	8.4	9.8	9.8
200	150	255	150	8.4	7.8	9.8	9.1
200	100	200	145	8.4	7.2	9.8	8.4
200	80	175	145	8.4	6.9	9.8	8.1
250	250	375	190	9	9	10.5	10.5
250	200	315	180	9	8.4	10.5	9.8
250	150	260	175	9	7.8	10.5	9.1
250	100	200	170	9	7.2	10.5	8.4
250	80	180	170	9	6.9	10.5	8.1

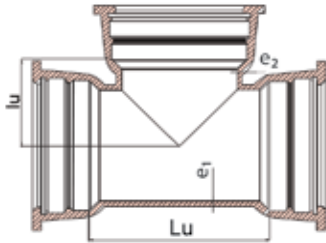

All socket tee - R.J

DN	dn	Lu mm	lu mm	K12		K14	
				e ₁ mm	e ₂ mm	e ₁ mm	e ₂ mm
300	300	435	220	9.6	9.6	11.2	11.2
300	250	375	210	9.6	9	11.2	10.5
300	200	320	205	9.6	8.4	11.2	9.8
300	150	260	200	9.6	7.8	11.2	9.1
300	100	205	195	9.6	7.2	11.2	8.4
350 †	350	500	255	10.2	10.2	11.9	11.9
400 †	400	560	280	10.8	10.8	12.6	12.6
500 †	500	680	340	12	12	14	14
600 †	600	800	400	13.2	13.2	15.4	15.4

† Other sizes of the same family can be manufactured at the order of customers.

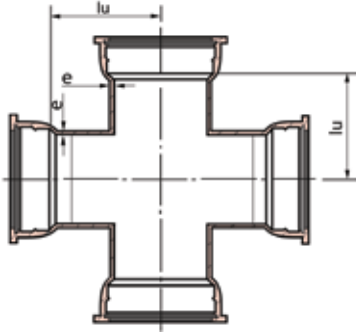

All socket cross R.J

DN	dn	e mm	Lu mm
80	80	8.12	85
100	100	8.4	95
150	150	9.1	125
200	200	9.8	155
250	250	10.5	190
300	300	11.2	220
350	350	11.9	255
400	400	12.6	280
500	500	14	340
600	600	15.4	400

† This type of cross can be produced with various sized sockets at the request of customers.

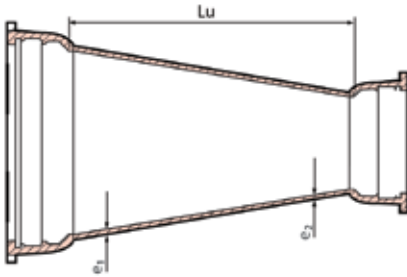

Double socket tyton taper
R.J

DN	dn	e ₁ mm	e ₂ mm	Lu mm
100	80	7.2	7	160
150	80	7.8	7	345
	100	7.8	7.2	170
200	100	8.4	7.2	550
	150	8.4	7.8	270
250	150	9	7.8	250
	200	9	8.4	150
300	150	9.6	7.8	350
	200	9.6	8.4	250
	250	9.6	9	150
350	200	10.2	8.4	360
	250	10.2	9	260
	300	10.2	9.6	160

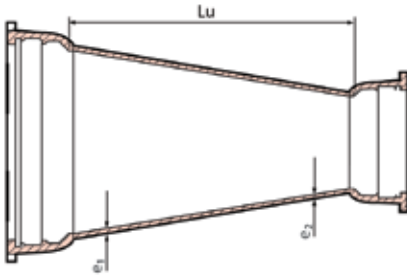

Double socket tyton taper
R.J

DN	dn	e ₁ mm	e ₂ mm	Lu mm
400	250	10.8	9	360
	300	10.8	9.6	260
	350	10.8	10.8	160
500	300	12	9.6	460
	350	12	10.8	360
	400	12	12	260
600	350	13.2	10.8	560
	400	13.2	12	460
	500	13.2	12	260
700	350	14.4	10.8	780
	500	14.4	12	480
	600	14.4	13.2	280
800	600	15.6	13.2	480
	700	15.6	14.4	280

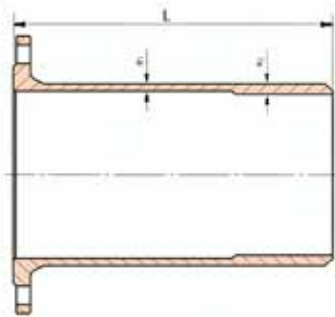

Flanged spigot for PVC PE pipe

F-KG



DN.OD	L mm	e ₁ mm	e ₂ mm
90	160	5.7	7.7
110	170	5.7	7.7
125	180	5.7	7.7
140	185	5.7	7.7
160	190	5.7	7.7
200*	210	5.7	7.7

* Drilling in OD200 size is possible based on PN10.

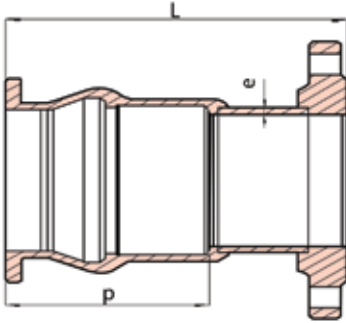

Flanged socket for PVC PE pipe



DN.OD	L mm	e mm	P mm
90	137	5.7	96
110	140	5.7	97
125	145	5.7	97
140	148	5.7	99
160	151	5.7	102
200*	157	5.7	105

* Drilling in OD200 size is possible based on PN10.

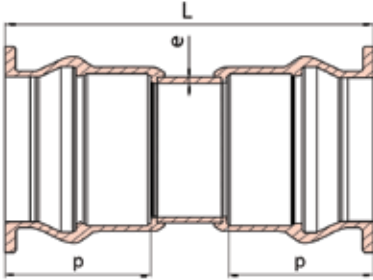

Collar for PVC PE pipe

DN.OD	L mm	e mm	P mm
90	265	5.7	96
110	275	5.7	97
125	295	5.7	97
140	305	5.7	99
160	315	5.7	102
200	335	5.7	105

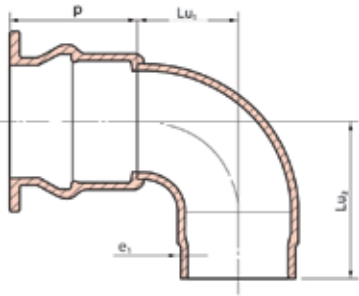

Socket-spigot bend for PVC PE pipe



A DN.OD	e ₁ mm	e ₂ mm	P mm	11.25°		22.5°		45°		90°	
				Lu ₁ mm	Lu ₂ mm	Lu ₁ mm	Lu ₂ mm	Lu ₁ mm	Lu ₂ mm	Lu ₁ mm	Lu ₂ mm
90	5.7	7.7	93	25	275	25	275	50	300	75	325
110	5.7	7.7	99	30	290	30	290	60	320	85	345
125	5.7	7.7	104	35	305	30	300	65	335	110	380
140	5.7	7.7	107	30	300	30	300	65	335	110	380
160	5.7	7.7	110	30	310	35	315	70	350	130	410
200	5.7	7.7	116	30	320	40	330	70	360	160	450

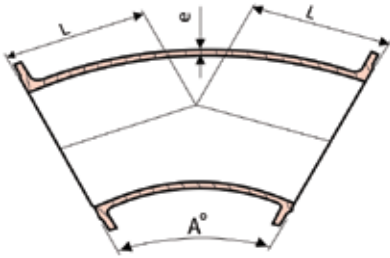

Double flanged bend for PVC PE pipe

A DN.OD	e mm	11.25°	22.5°	45°	90°
		L mm	L mm	L mm	L mm
90	5.7	25	30	50	165
110	5.7	29.5	29.5	59.5	160
125	5.7	30	30	65	200
140	5.7	30	35	70	200
160	5.7	35	35	70	200
200*	5.7	30	40	70	250

* Drilling in OD200 size is possible based on PN10.

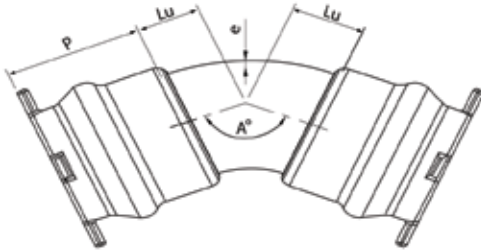

Double socket bend
for PVC PE pipe

A DN.OD	P mm	11.25°		22.5°		45°		90°	
		Lu mm	e mm	Lu mm	e mm	Lu mm	e mm	Lu mm	e mm
90	93	25	5.7	30	5.7	50	5.7	75	5.7
110	99	30	5.7	30	5.7	60	5.7	85	5.7
125	104	30	5.7	30	5.7	65	5.7	110	5.7
140	107	30	5.7	35	5.7	70	5.7	110	5.7
160	110	35	5.7	35	5.7	70	5.7	130	5.7
200	116	35	5.7	40	5.7	70	5.7	160	5.7

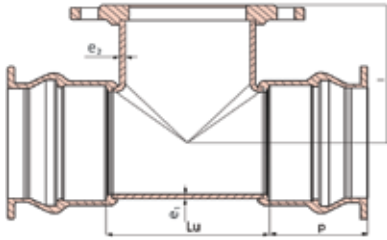

Double socket with
flanged tee for PVC PE pipe

MMA-KS

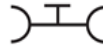

DN.OD	dn.od	DN Flange	P mm	e ₁ mm	Lu mm	e ₂ mm	l mm
90	90	80	93	5.7	115	5.7	160
110	90	80	99	5.7	105	5.7	170
110	110	100	99	5.7	125	5.7	170
125	90	80	104	5.7	105	5.7	170
125	110	100	104	5.7	125	5.7	180
125	125	125	104	5.7	150	5.7	180
140	90	80	107	5.7	105	5.7	185
140	110	100	107	5.7	125	5.7	195
140	125	125	107	5.7	150	5.7	200
140	140	125	107	5.7	150	5.7	200
160	90	80	110	5.7	105	5.7	200
160	110	100	110	5.7	125	5.7	205
160	125	125	110	5.7	150	5.7	210
160	140	125	110	5.7	150	5.7	220
160	160	150	110	5.7	175	5.7	220
200	90	80	116	5.7	140	5.7	225
200	110	100	116	5.7	160	5.7	230
200	125	125	116	5.7	185	5.7	240
200	140	125	116	5.7	185	5.7	245
200	160	150	116	5.7	210	5.7	245
200	200*	200	116	5.7	260	5.7	250

* Drilling in OD200 size is possible based on PN10.

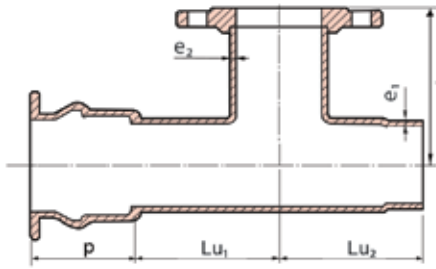

Socket spigot
with flanged tee for PVC PE pipe

DN.OD	dn.od	P mm	e ₁ mm	e ₂ mm	Lu ₁ mm	Lu ₂ mm	l mm
90	90	93	5.7	7.7	58	167	160
110	90	99	5.7	7.7	53	185	170
110	110	99	5.7	7.7	63	185	170
125	90	104	5.7	7.7	53	197	170
125	110	104	5.7	7.7	63	197	180
125	125	104	5.7	7.7	75	197	180
140	90	107	5.7	7.7	53	210	185
140	110	107	5.7	7.7	63	210	195
140	125	107	5.7	7.7	75	210	200
140	140	107	5.7	7.7	75	210	200
160	90	110	5.7	7.7	53	227	200
160	110	110	5.7	7.7	63	227	205
160	125	110	5.7	7.7	75	227	210
160	140	110	5.7	7.7	75	227	220
160	160	110	5.7	7.7	88	227	220
200	90	116	5.7	7.7	70	260	225
200	110	116	5.7	7.7	80	260	230
200	125	116	5.7	7.7	93	260	240
200	140	116	5.7	7.7	93	260	245
200	160	116	5.7	7.7	105	260	245
200	200 *	116	5.7	7.7	130	260	250

* Drilling in OD200 size is possible based on PN10.

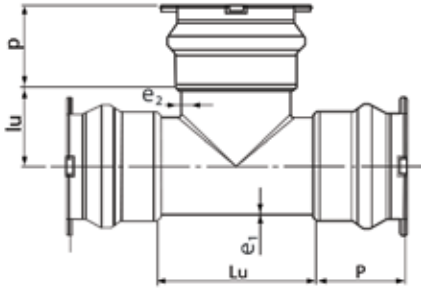

All socket tee for PVC PE pipe

MMB-KS



DN.OD	dn.od	P mm	p mm	e ₁ mm	Lu mm	e ₂ mm	lu mm
90	90	93	93	5.7	105	5.7	50
110	90	99	93	5.7	105	5.7	60
110	110	99	99	5.7	125	5.7	60
125	90	104	93	5.7	105	5.7	70
125	110	104	99	5.7	125	5.7	70
125	125	104	104	5.7	150	5.7	70
140	90	107	93	5.7	105	5.7	75
140	110	107	99	5.7	125	5.7	75
140	125	107	104	5.7	150	5.7	75
140	140	107	107	5.7	150	5.7	75
160	90	110	93	5.7	105	5.7	85
160	110	110	99	5.7	125	5.7	85
160	125	110	104	5.7	150	5.7	85
160	140	110	107	5.7	150	5.7	85
160	160	110	110	5.7	175	5.7	85
200	90	116	93	5.7	140	5.7	105
200	110	116	99	5.7	160	5.7	105
200	125	116	104	5.7	160	5.7	105
200	140	116	107	5.7	185	5.7	105
200	160	116	110	5.7	210	5.7	105
200	200	116	116	5.7	240	5.7	105

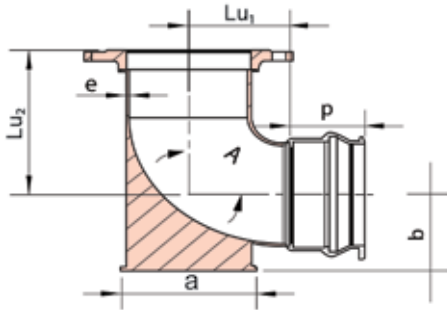

Socket flanged
bend duckfoot for PVC PE

EN-KS



DN.OD	e mm	P mm	Lu ₁ mm	Lu ₂ mm	a mm	b mm
90	5.7	93	75	165	107	110
110	5.7	99	85	160	126	125
125	5.7	104	110	200	146	120
140	5.7	107	110	200	164	128
160	5.7	110	130	200	186	132
200*	5.7	116	160	250	220	152

* Drilling in OD200 size is possible based on PN10.

PVC PE pipe flanged

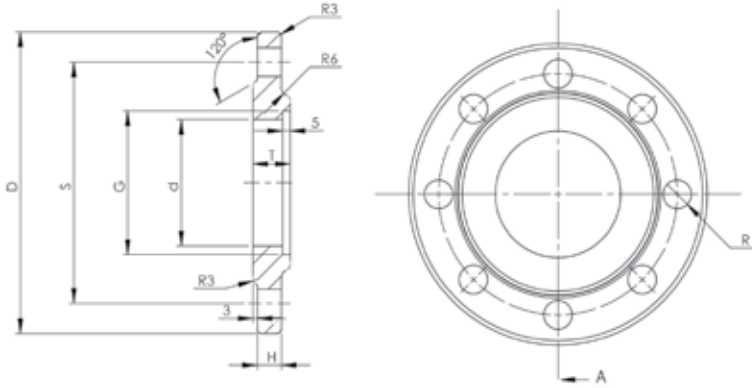

OD	D mm	S mm	d mm	H mm	T mm	G mm	R mm
90	200	160	84	16	25	95.4	19
110	220	180	100	16	25	115.4	19
125	250	210	119	16	25	130.4	19
140	250	210	125	16	25	145	19
160	285	240	150	16	25	164.6	23
200	340	295	193	17	25	204.4	23

Other technical remarks

Note 1: All dimensions of Tyton, anti-seismic and light pipe fittings are in millimeters and weights in kilograms. Dimensions and weights are also listed without considering the tolerance. For more information, contact with Hanyco technical experts.

Note 2: In designing some of anti-seismic and light pipe fittings, in addition to complying with international standards, factory standards have also been used.

Note 3: Due to the casting capabilities of the Lost Foam Casting method, which is the main fittings production method in Hamoun Nyzeh Company, it is possible to produce and supply special custom fittings according to the customer's request.

For more information contact Hanyco technical experts.

References

- 1- ISO 2531:2009 Ductile iron pipes, fittings, accessories and their joints for water applications
- 2- ISO 2531:1998 Ductile iron pipes, fittings, accessories and their joints for water applications
- 3- EN 545:2010 Ductile iron pipes, fittings, accessories and their joints for water pipelines. Requirements and test methods
- 4- EN 545:2007 Ductile Iron Pipes, Fittings, Accessories And Their Joints For Water Pipelines - Requirements And Test Methods
- 5- EN 598 Ductile iron pipes, fittings, accessories and their joints for sewerage applications - requirements and test methods
- 6- ISO 7186 Ductile iron products for sewerage applications
- 7- ISO 4633 Rubber seals(Joint rings for water supply, drainage and sewerage pipelines Specification for materials)
- 8- EN 681-1 Elastomeric seals. Material requirements for pipe joint seals used in water and drainage applications
Vulcanized rubber
- 9- ISO 10804 Restrained joint systems for ductile iron pipelines Design rules and type testing
- 10-ISO 16134 Earthquake-resistant and subsidence-resistant design of ductile iron pipelines
- 11-ISO 8180 Ductile iron pipelines (Polyethylene sleeving for site application)
- 12-ISO 4179 Ductile iron pipes and fittings for pressure and non-pressure pipelines(Cement mortar lining)
- 13-ISO 8179-1 & 2 External zinc-based coating Part 1: Metallic zinc with finishing layer
- 14-EN 14901 Ductile iron pipes, fittings and accessories - Epoxy coating (heavy duty) of ductile iron fittings and accessories - Requirements and test methods
- 15-BS EN 1171:2015 Industrial valves. Cast iron gate valves
- 16-EN 124 Manhole Covers

Additional Standards

- 17-EN 1092-2 Flanges and their joints - Circular flanges for pipes, valves, fittings and accessories, PN designated
Part 2. Cast iron flanges
- 18-ISO 7005 -2 Pipe flanges - Part 1: Steel flanges for industrial and general service piping systems
- 19-ISO 6708 Pipework components - Definition and selection of DN (nominal size)
- 20-ISO 7268 Pipe components Definition of nominal pressure
- 21-ISO 4016 Hexagon head bolts with nut, production class C
- 22-ISO 4034 Hexagon Nuts, production class C
- 23-EN 197-1 Cement Composition, specifications and conformity criteria for common cements
- 24-EN 196-1 Methods of testing cement Determination of strength
- 25-ISO 7483 Dimensions of gaskets for use with flanges to ISO 7005
- 26-ISO 6506-1 Metallic materials - Brinell hardness test - Part 1: Test method
- 27-EN 10002-1 Metallic Materials - Tensile Testing - Part 1
- 28-DVGW-W270 Microbial Recovery in Materials in Contact with Drinking Water
- 29 DVGW-w348 Requirements of bituminous coatings of ductile iron fittings and in the jointing area of ductile iron pipes and unalloyed and low-alloyed steel pipes

